

RELAP-7 Simulation Resolving an SBO Scenario on a Simplified Geometry of a BWR

Hongbin Zhang, Haihua Zhao, Ling Zou, David Andrs, John Peterson, Ray Berry, and Richard Martineau



August 2013

U.S. Department of Energy

Office of Nuclear Energy

DISCLAIMER

This information was prepared as an account of work sponsored by an agency of the U.S. Government. Neither the U.S. Government nor any agency thereof, nor any of their employees, makes any warranty, expressed or implied, or assumes any legal liability or responsibility for the accuracy, completeness, or usefulness, of any information, apparatus, product, or process disclosed, or represents that its use would not infringe privately owned rights. References herein to any specific commercial product, process, or service by trade name, trade mark, manufacturer, or otherwise, does not necessarily constitute or imply its endorsement, recommendation, or favoring by the U.S. Government or any agency thereof. The views and opinions of authors expressed herein do not necessarily state or reflect those of the U.S. Government or any agency thereof.

**RELAP-7 Simulation Resolving an SBO Scenario on a Simplified
Geometry of a BWR**

Hongbin Zhang, Haihua Zhao, Ling Zou, David Andrs,
John Peterson, Ray Berry, and Richard Martineau

August 2013

**Idaho National Laboratory
Idaho Falls, Idaho 83415**

<http://www.inl.gov>

**Prepared for the
U.S. Department of Energy
Office of Nuclear Energy
Under DOE Idaho Operations Office
Contract DE-AC07-05ID14517**

EXECUTIVE SUMMARY

The RELAP-7 code is the next generation nuclear reactor system safety analysis code being developed at the Idaho National Laboratory (INL). RELAP-7 will become the main reactor systems toolkit for the Risk-Informed Safety Margin Characterization Pathway of the Light Water Reactor Sustainability Program and the next generation tool in the RELAP reactor safety/systems analysis application series (i.e., the replacement for RELAP5). The code is being developed based on Idaho National Laboratory's modern scientific software development framework – MOOSE (the Multi-Physics Object-Oriented Simulation Environment).

During Fiscal Year 2013, a number of physical components with two-phase flow capability have been developed to support the simplified boiling water reactor (BWR) station blackout analyses. The case selected for demonstration calculation is built from the specifications documented in an Organization for Economic Cooperation and Development benchmark problem for BWR turbine trip analysis. The reference design for the benchmark problem was from the Peach Bottom-2 nuclear station, which is a General Electric BWR-4 design. The demonstration case includes the major components for the primary system of a BWR, as well as the safety system components for reactor core isolation cooling (RCIC) and the wet well of a BWR containment. The case was initially run to steady-state with RELAP-7. The station blackout transient simulations were subsequently initiated by using the INL-developed RAVEN code. Two scenarios for the station blackout simulations have been considered. Scenario I represents an extreme station blackout accident with no safety injection functioning. The reactor core could experience dry out fairly quickly with this scenario. Scenario II represents a more probable station blackout accident progression with the RCIC system functioning. In this scenario, the RCIC system is fully coupled with the reactor primary system and the safety injection to provide makeup cooling water to the reactor core from the suppression pool is dynamically simulated. With the RCIC system functioning, the core dry out is significantly postponed when compared to the results from Scenario I. This fully coupled RCIC system simulation capability represents the first-of-a-kind simulation capability. Sensitivity studies have also been carried out to study the effect of RCIC control strategy with varying core makeup cooling water mass flow rates.

The next stage of development will be to demonstrate more refined BWR station blackout analyses with more realistic geometries, to be reported in the next demonstration simulation report.

ACKNOWLEDGEMENTS

Acknowledgement is given to our collaborators Rui Hu and Thomas Fanning from Argonne National Laboratory. Their close collaboration and support is essential to the success of this project. We also would like to acknowledge Stephen Hess and Greg Swindlehurst of the Electric Power Research Institute for their valuable contributions to development of the RELAP-7 applications. Their expertise in nuclear engineering, systems analysis and understanding of industry needs is much appreciated. We also acknowledge contributions of the MOOSE team.

CONTENTS

EXECUTIVE SUMMARY	iii
ACKNOWLEDGEMENTS.....	v
FIGURES.....	viii
TABLES	x
ACRONYMS.....	xi
1. INTRODUCTION	1
2. DESCRIPTION OF COMPONENTS	2
2.1 Separator Dryer.....	2
2.2 Down Comer.....	3
2.3 Valve.....	3
2.4 Reactor Core Isolation Cooling Turbine and Reactor Core Isolation Cooling Pump.....	4
2.5 Wet Well.....	5
2.6 Reactor.....	5
3. DESCRIPTION OF A SIMPLIFIED BOILING WATER REACTOR PLANT SYSTEM.....	5
4. SIMULATION RESULTS	8
4.1 Simulation Results for Station Blackout Scenario I – Without Safety Injection	8
4.2 Simulation Results for Station Blackout Scenario II – Fully Coupled Reactor Core Isolation Cooling Safety Injection System.....	14
5. CONCLUSION AND FUTURE WORK.....	23
6. REFERENCES	24
Appendix A: Input Files for SBO Scenario II Base Case	25

FIGURES

Figure 1. Diagram of a separator dryer component.	3
Figure 2. Diagram of a down comer component.....	3
Figure 3. A simplified wet well model.	5
Figure 4. Schematics of a simplified boiling water reactor plant system.	6
Figure 5. Decay heat curve in percentage used in the station blackout transient simulation.....	8
Figure 6. Schematics for boiling water reactor station blackout simulation – Scenario I.....	9
Figure 7. RELAP-7 calculated void fraction distribution in the reactor core (the bottom line) and the separator stand pipe (the top line) at steady-state for Scenario I.....	9
Figure 8. RELAP-7 calculated fluids density at steady-state for Scenario I.....	10
Figure 9. RELAP-7 calculated pressure distribution at steady-state for Scenario I.....	10
Figure 10. RELAP-7 calculated down comer liquid level during station blackout for Scenario I.	11
Figure 11. RELAP-7 calculated peak clad temperature during station blackout for Scenario I.	12
Figure 12. RELAP-7 calculated fluids density at the end of simulation for Scenario I.....	12
Figure 13. RELAP-7 calculated fluids velocity at the end of simulation for Scenario I.....	13
Figure 14. RELAP-7 calculated fluids void fraction in the core (the bottom line) and in the separator stand pipe (the top line) at the end of simulation for Scenario I.	13
Figure 15. Steady-state pressure distribution for Scenario II.....	14
Figure 16. RELAP-7 calculated pressure distribution at $t = 22937$ s for the Scenario II base case.....	16
Figure 17. RELAP-7 calculated temperature distribution at $t = 22937$ s for the Scenario II base case.....	16
Figure 18. RELAP-7 calculated fluid density distribution at $t = 22937$ s for the Scenario II base case.....	17
Figure 19. Reactor core isolation cooling turbine shaft work for the Scenario II base case.....	18
Figure 20. Reactor vessel pressure for the Scenario II base case.....	19
Figure 21. Down comer water level for the Scenario II base case.....	19
Figure 22. Peak clad temperature for the Scenario II base case.....	19
Figure 23. Wet well pool temperature for the Scenario II base case.	20
Figure 24. Wet well pool level for the Scenario II base case.....	20

Figure 25. Wet well gas space pressure for the Scenario II base case.	20
Figure 26. Turbine shaft work for Scenario II with larger reactor core isolation cooling flow rate.	21
Figure 27. Reactor vessel pressure for Scenario II with larger reactor core isolation cooling flow rate. ...	21
Figure 28. Down comer water level for Scenario II with larger reactor core isolation cooling flow rate. .	21
Figure 29. Peak clad temperature for the Scenario II with larger reactor core isolation cooling flow rate .	22
Figure 30. Turbine shaft work for Scenario II with lower reactor core isolation cooling flow rate.	22
Figure 31. Reactor vessel pressure for Scenario II with lower reactor core isolation cooling flow rate. ...	22
Figure 32. Down comer water level for Scenario II with lower reactor core isolation cooling flow rate...	23
Figure 33. Peak clad temperature for Scenario II with lower reactor core isolation cooling flow rate.	23

TABLES

Table 1. Major components developed to perform boiling water reactor station blackout analysis.....	1
Table 2. Core model parameters and fuel rod geometry data.	7
Table 3. Major component parameters for the simplified boiling water reactor plant configuration.	7

ACRONYMS

0-D	zero dimensional
1-D	one dimensional
2-D	two dimensional
BWR	boiling water reactor
FY	fiscal year
MOOSE	Multi-Physics Object-Oriented Simulation Environment
NPSHa	available net positive suction head
RCIC	reactor core isolation cooling
RELAP5	Reactor Excursion and Leak Analysis Program 5
RELAP-7	Reactor Excursion and Leak Analysis Program 7
SBO	station blackout

RELAP-7 Simulation Resolving an SBO Scenario on a Simplified Geometry of a BWR

1. INTRODUCTION

The RELAP-7 code is the next generation of nuclear reactor system safety analysis code being developed at the Idaho National Laboratory [1]. RELAP-7 will become the main reactor systems simulation toolkit for the Risk Informed Safety Margin Characterization Pathway (RISMC) of the Light Water Reactor Sustainability Program and the next generation tool in the RELAP reactor safety/systems analysis application series (i.e., the replacement for RELAP5). The RELAP-7 code development is taking advantage of the progresses made in the past several decades to achieve simultaneous advancement of physical models, numerical methods, and software design. RELAP-7 utilizes the Idaho National Laboratory's MOOSE (Multi-Physics Object-Oriented Simulation Environment) framework for solving computational engineering problems in a well-planned, managed, and coordinated way. This allows RELAP-7 development to focus strictly on systems analysis-type physical modeling and gives priority to retention and extension of RELAP5's multidimensional system capabilities.

A real reactor system is very complex and may contain hundreds of different physical components. Therefore, it is impractical to preserve real geometry for the whole system. Instead, simplified thermal hydraulic models are used to represent (via "nodalization") the major physical components and describe major physical processes (such as fluid flow and heat transfer). There are three main types of components developed in RELAP-7: (1) one-dimensional (1-D) components, (2) zero-dimensional (0-D) components for setting a boundary, and (3) 0-D components for connecting 1-D components.

During Fiscal Year (FY) 2013, two-phase flow modeling capability has been developed in the RELAP-7 code, aimed at demonstrating simulation of a boiling water reactor (BWR) with simplified geometries under extended station blackout (SBO) transient conditions. A number of components developed during FY 2012 for single-phase pressurized water reactor model analysis (such as Pipe and Core Channel) have been extended to include two-phase flow modeling capability. Additionally, a set of new components have been developed, including the Separator Dryer, Down Comer, Valve, Turbine, and Wet Well components. It is noted that the two-phase flow model used in this milestone report is the homogeneous equilibrium model that is a reduced subset of the seven-equation model. The full seven-equation, two-phase model has been implemented into RELAP-7 and the results have been demonstrated with a few components [2]. However, it needs further development to be able to perform BWR transient simulations for the complete component set. We plan to demonstrate more realistic BWR SBO simulations using the seven-equation model in a subsequent milestone report. Table 1 lists the major components developed to demonstrate BWR SBO transient analysis.

Table 1. Major components developed to perform boiling water reactor station blackout analysis.

Component name	Descriptions	Dimension
Pipe	1-D fluid flow within 1-D solid structure with wall friction and heat transfer	1-D
Core Channel	Simulating reactor flow channel and fuel rod, including 1-D flow and 1-D or two-dimensional (2-D) fuel rod heat conduction	1-D
Heat Exchanger	Co-current or counter-current heat exchanger model, including fluid flow in two sides and heat conduction through the solid wall	1-D
Time Dependent Volume	Provides pressure, temperature, and void	0-D

Component name	Descriptions	Dimension
	fraction boundary conditions for 1-D components	
Time Dependent Junction	Provides velocity, temperature, and void fraction boundary conditions for 1-D components	0-D
Branch	Multiple inlets and outlets 0-D junction, which provides form loss coefficients (K)	0-D
Pump	A junction model with momentum source connecting two 1-D components	0-D
Separator Dryer	Separate steam and water with mechanical methods	0-D
Down Comer	Large volume to mix different streams of water and steam and to track the water level	0-D
Valve	Simulate control mechanisms of real valves in a hydrodynamic system	0-D
Turbine	A simplified dynamical turbine model to simulate a reactor core isolation cooling (RCIC) turbine, which drives the RCIC pump through a common shaft	0-D
Wet Well	Simulate a BWR suppression pool and its gas space	0-D
Reactor	A virtual component that allows users to input the reactor power	0-D

2. DESCRIPTION OF COMPONENTS

The functions of the pipe, core channel, heat exchanger, time dependent volume, time dependent junction, branch, and pump have been previously described in a milestone report (INL/EXT-12-25924) [1] and will not be repeated here. The following sections briefly discuss the functions of the newly developed components listed in Table 1. Note that Appendix A contains the full input deck for one of the SBO analysis cases as an example of the structure used to create the components and associated control logic.

2.1 Separator Dryer

BWRs use a steam separator to increase the quality of steam prior to generation of mechanical energy in the turbine. A steam separator component is based on the principle of centrifugal separation, where the liquid/gas phase separation occurs as a mixture of water and steam flows upward in a vortex motion within vertical separator tubes. Therefore, the outflows of the steam separator are a flow of steam from the top exit and a flow of liquid water from the discharge to the bulk water surrounding the separator barrel. Typically, the quality of the steam at the outlet of the separator is at least 90%. In addition, steam dryers are used to further increase the quality of steam to ensure that the steam is dry. In RELAP-7 the separator dryer component is developed to model both the steam separators and moisture dryers together. At this time only the ideal separation model with perfect steam separation has been implemented into RELAP-7. The mechanistic separator and dryer models will be implemented in the future. The steam separator dryer component has one inlet and two outlets (shown in Figure 1). Each connection has a form loss coefficient K , which generally accounts for pressure loss due to expansion/contraction, mixing, and friction.

2.2 Down Comer

The BWR pressure vessel down comer is a 0-D model with a large volume that connects the feedwater pipe, the separator dryer discharge, the steam dome, and the down comer outlet (Figure 2). The volume is filled with vapor at the top and liquid at the bottom. During transients, the liquid level will increase or decrease (depending on the nature of the transient), which affects the mass flow rate through the reactor core; therefore, it is important to track the liquid level for transient analysis.



Figure 1. Diagram of a separator dryer component.

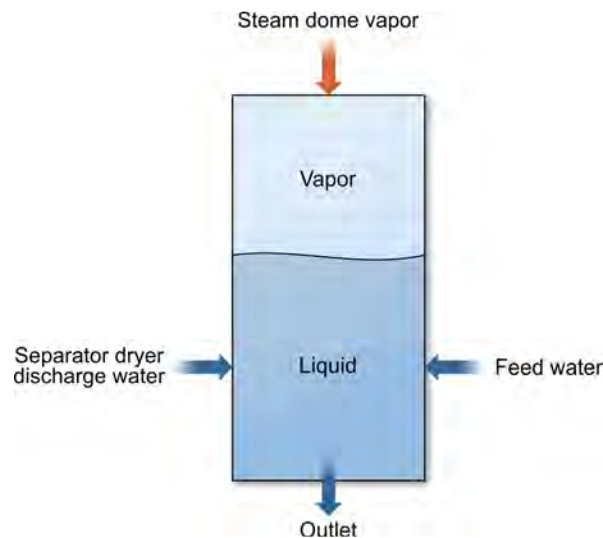

Figure 2. Diagram of a down comer component.

2.3 Valve

The current valve component developed in RELAP-7 is a simplified model to simulate the fundamental functions (i.e. open and close) of generic valves. The valve component is a junction type of components and it connects one pipe on each side. The valve is initiated with a given user input (i.e., fully open or fully closed). It then starts to react (i.e., close or open) and is triggered either by a preset user given trigger time or by a trigger event, which requires the RAVEN code control logic (for additional

detail on the RAVEN capability refer to the INL report INL/EXT-13-29510 [3]). In its opening status, either fully open or partially open, it serves as a regular flow junction with form losses. In its fully closed status, the connected two pipes are physically isolated. The current valve model also includes the gradually open/close capability similar to a motor driven valve to simulate the physical behavior of a valve open/close procedure. It also has the benefit of avoiding spurious numerical oscillations that are caused by an instantaneous open/close procedure. More specific valve components to be developed in the future (e.g., gate valve and check valve) will be necessary to enhance the RELAP-7 capabilities for engineering analysis.

2.4 Reactor Core Isolation Cooling Turbine and Reactor Core Isolation Cooling Pump

The reactor core isolation cooling (RCIC) system provides makeup cooling water to the reactor vessel for core cooling when the main steam lines are isolated and the normal supply of water to the reactor vessel is lost. The RCIC system consists of a turbine and a turbine-driven pump, piping, and the valves necessary to deliver water to the reactor vessel at accident conditions. The turbine is driven by steam that is supplied by the main steam lines. It is designed to rapidly accelerate from standby to the full load condition within the specified time period. The turbine exhaust is routed to the suppression pool (i.e., the wet well).

A turbine is a device that converts energy contained in high-pressure and high-temperature fluid into mechanical work. The complicated configuration of a turbine precludes a complete first-principles model, at least for the purpose of system transient calculations. In RELAP-7, we developed a simple turbine component as a junction without volume. Thermal inertia in the solid structures and fluid is ignored. To dynamically simulate a turbine, a turbine characteristics curve is used in the model, which reflects the dynamic behavior of a turbine. Major physical parameters for the turbine model include thermal efficiency, nominal mass flow rate, design pressure ratio, and design stagnation inlet temperature and pressure.

The turbine-driven pump supplies the makeup water from the condensate storage tank, with the alternate supply from the suppression pool, to the reactor vessel via the feedwater piping. The RCIC pump is a horizontal, multi-stage, centrifugal pump.

The RCIC system is sized to keep up with water inventory losses due to boiling caused by decay heat. Initiation of this system occurs automatically upon a low water level in the reactor vessel or manually by the operator. The RCIC system operates independently of AC power, service air, or external cooling water systems. This system was one of the very few safety systems still available during the Fukushima accident to delay the core meltdown for 1 or 2 days after the tsunami hit the nuclear facility. The only required external energy source is battery to control the system. Therefore, battery time is the key parameter for determining the availability of the RCIC system during accident conditions. Additional parameters to disable the system are high-suppression pool temperature and wet well pressure. Although both parameters are available to be used as control signals, in this first demonstration of simplified SBO analysis, we will assume that finite battery time stops the RCIC system. It is also noted that, although in a real plant the reactor pressure is mainly controlled by safety relief valves, the simulations given here will not include pressure release through safety relief valves. Therefore, the RCIC system also controls the system pressure in our simulations. Safety relief valves will be included in the next stage of SBO simulations.

2.5 Wet Well

The wet well of BWR containment consists of the suppression pool and the gas space above it. The suppression pool is the alternate source of water for the RCIC pump and it condenses steam from the turbine exhaust or from the safety relief valves. The RCIC pump draws water from the suppression pool. The model will simulate the water and gas spaces. Figure 3 shows the schematic of the simplified model. Major assumptions include (1) the suppression pool is well mixed; (2) kinetic energy is neglected in both spaces, and therefore, the water space pressure follows hydrostatic distribution; (3) no mass transfer between the water and gas spaces; (4) the gas space is composed of 100% nitrogen gas; (5) the geometry of the wet well is a rectangular shape; and (6) no steam venting from the dry well to the suppression pool. Note that due to these assumptions, this model cannot be used for loss-of-coolant accident analysis. However, with these assumptions, mass and energy conservations are imposed for both the gas and water spaces. Assuming a separate pressure for the gas space, allows development of another pressure equation for the water level.

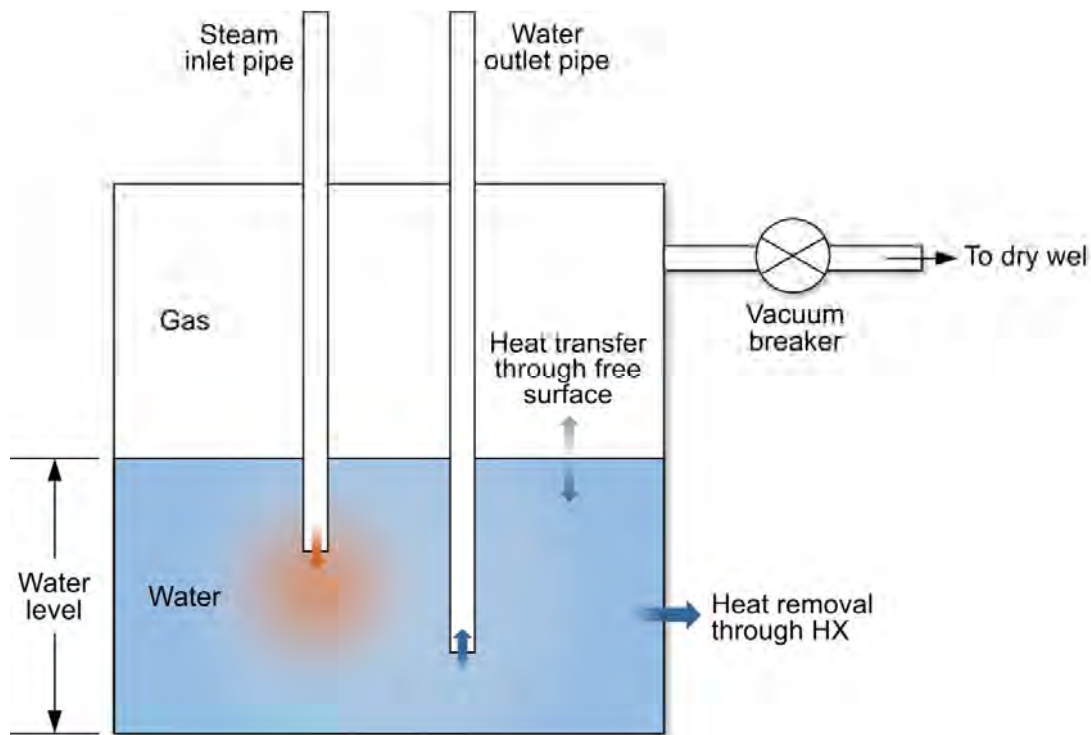

Figure 3. A simplified wet well model.

2.6 Reactor

The reactor component is a virtual component added in RELAP-7 to allow users to specify the reactor power (i.e., steady-state power or decay heat curve) or heat source.

3. DESCRIPTION OF A SIMPLIFIED BOILING WATER REACTOR PLANT SYSTEM

A simplified BWR plant system model has been built based on the parameters specified in the Organization for Economic Cooperation and Development turbine trip benchmark problem [4]. The reference design for the Organization for Economic Cooperation and Development BWR Turbine Trip

benchmark problem is derived from Peach Bottom-2, which is a General Electric-designed BWR-4 nuclear power plant, with a rated thermal power of 3,293 MW.

Figure 4 shows the schematics of the simplified BWR plant system to be analyzed with RELAP-7. The reactor vessel model consists of the down comer model, the lower plenum model, the reactor core model, the upper plenum model, the separator dryer model, the steam dome model, the main steam line model, the feedwater line model, the primary pump model, the RCIC turbine model, the RCIC pump model, and the wet well model.

A Core channel model (i.e., flow channel with heat structure attached to it) was used to describe the reactor core. Each core channel represents thousands of real cooling channels and fuel rods. To speed up the transient simulation, only one core channel was used to represent the entire core; bypass flow was ignored. The lower plenum, upper plenum and steam dome are modeled with branch models. External to the reactor vessel, the main steam line is connected to the steam dome. A time dependent volume is attached to the main steam line to provide the necessary boundary conditions for the steam flow. A feedwater line is connected to the down comer model. A time dependent volume is attached to the feedwater line to provide the necessary boundary conditions for the feedwater. The safety injection system includes the RCIC turbine and RCIC pump, as well as the containment wet well and dry well. Valves are placed at various locations to provide the flow control functions of the plant system. Notably missing from this simplified BWR model are the jet pumps and the recirculation loops that allow the operator to vary coolant flow through the core and change reactor power. Instead, for this case study, a pump model is used to represent the functions of the jet pumps and the recirculation loops.

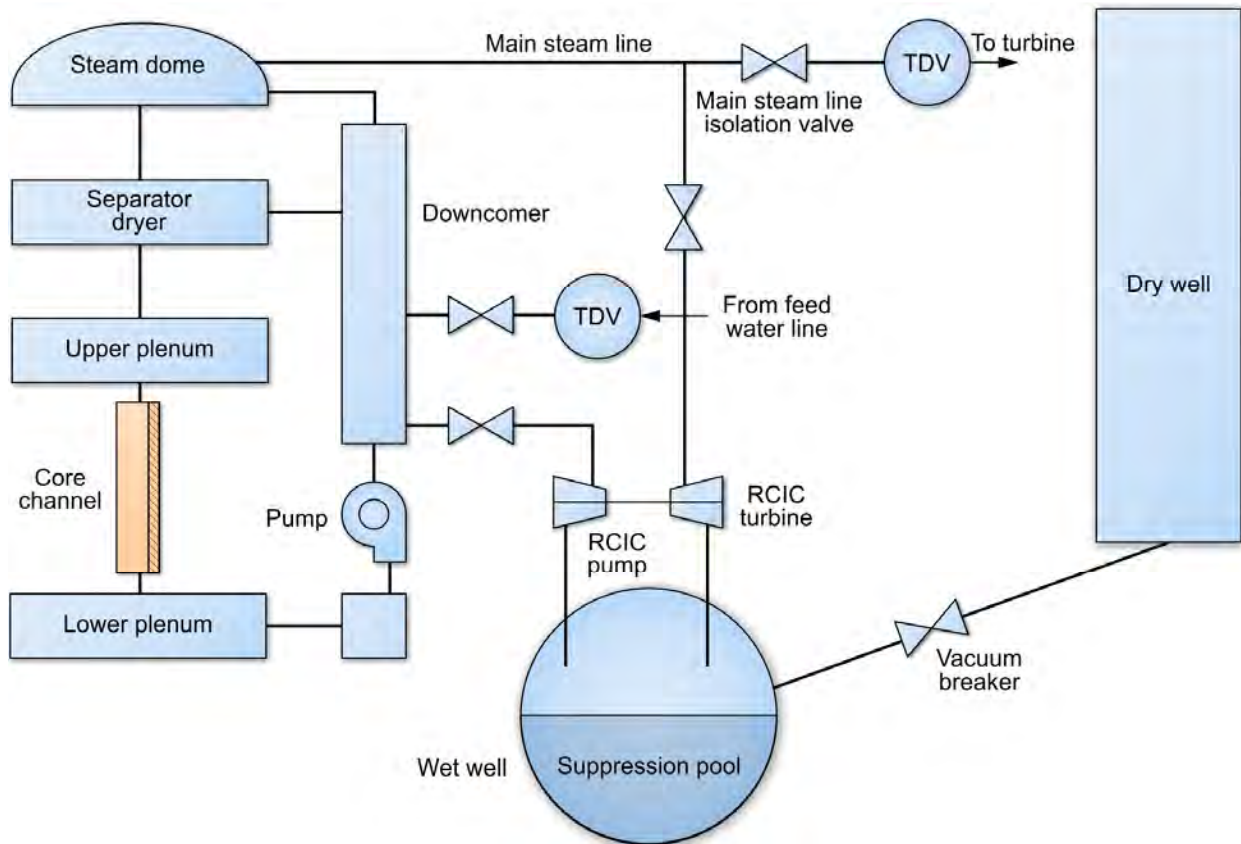

Figure 4. Schematics of a simplified boiling water reactor plant system.

The following provides more detailed information on the geometry and parameters used for the model problem simulation.

The Peach Bottom-2 reactor core consists of 764 fuel assemblies. The initial cycle was selected as the reference design cycle for the simulations done in this report. In the initial cycle, 7x7 fuel rod lattice type assemblies with no water rods were loaded. The active core height specified was 3.6576 m. For ease of preparing the input file, we used 3.66 m as the active core height in our calculations. The fuel assembly and fuel rod geometry data were taken from reference [3] and shown in Table 2.

Table 2. Core model parameters and fuel rod geometry data.

Core thermal power (MW)	3,293
Core height (m)	3.66
Core flow area (m ²)	7.8
Fuel pellet diameter (cm)	1.21158
Gap thickness (cm)	0.01524
Clad outer diameter (cm)	1.43002
Fuel rod pitch (cm)	1.8745
Number of fuel rods per assembly	49
Assembly pitch (cm)	15.24
Heat transfer surface area per unit fluid volume	235.4927
Hydraulic diameter (cm)	1.3597

The major parameters required to build the simplified BWR plant system configurations also were obtained from reference [3] and some key data are shown in Table 3.

Table 3. Major component parameters for the simplified boiling water reactor plant configuration.

Component Name	Volume (m ³)	Area (m ²)	Axial Elevation (Top) Relative to the Bottom of the Vessel (m)
Lower Plenum	61.48	11.64	5.28
Reactor Core	28.55	7.80	8.94
Upper Plenum	26.99	14.36	10.82
Separator Standpipe	10.69	3.93	13.54
Separator Dryer (S/D)	19.30	10.27	15.42
S/D Steam Outlet Pipe	0.393	3.93	15.42
S/D Liquid Discharge Pipe	3.93	3.93	14.48
Steam Dome	178.19	26.19	22.32
Main Steam Line	2.64	1.32	18.92
Down Comer	201.30	15.0	15.52
Feedwater Line	3.96	1.32	12.52
Wet Well Water Space	3570	892.5	-12 (bottom)
Wet Well Gas Space	3570	892.5	-4 (top)
RCIC Turbine	NA	NA	-3
RCIC Pump	NA	NA	-3

4. SIMULATION RESULTS

Two types of RELAP-7 SBO accident simulations were performed on the simplified Peach Bottom-2 plant system model described in the previous section. The first type (Scenario I) includes only the primary system, which assumes that the safety injection system does not function during SBO. This represents an extreme scenario of the SBO accident. The second type (Scenario II) of simulations includes both the primary system and the fully coupled RCIC system to provide the necessary cooling water injection into the reactor core during SBO. This second scenario is a more realistic representation of a BWR plant transient behavior during SBO.

The RELAP-7 input files were built for both scenarios and the cases were first run such that the plant system reaches steady state with a rated thermal power of 3,293 MW. Subsequently, the restart cases were run to perform the transient simulations of the SBO scenarios. Reactor scram was assumed to occur at SBO initiation. Therefore, the heating source comes from the decay heat of the fuel in the reactor core. Figure 5 shows the decay heat curve used in the SBO simulations. The sinusoidal power density distribution in the axial direction was used in both the steady-state and SBO transient simulations.

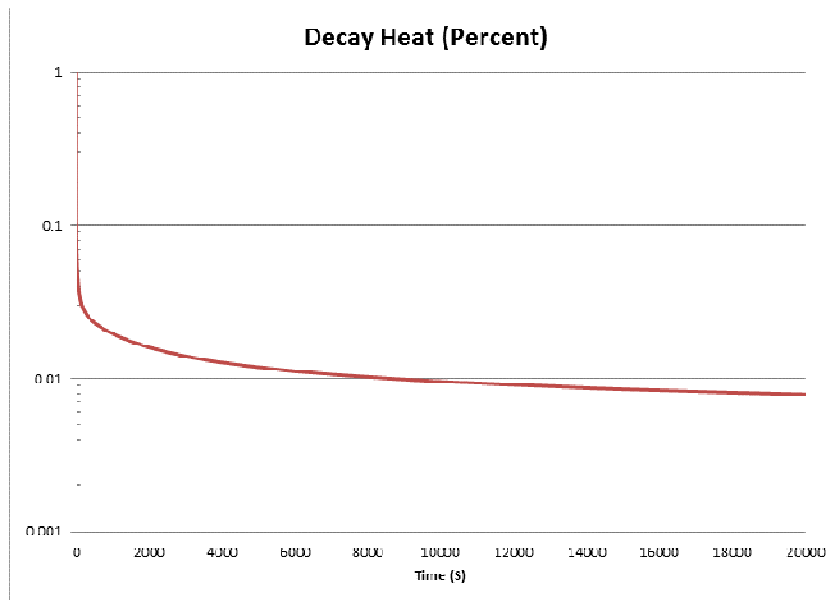

Figure 5. Decay heat curve in percentage used in the station blackout transient simulation.

4.1 Simulation Results for Station Blackout Scenario I – Without Safety Injection

In this scenario, it is assumed that the safety injection system fails to start and function properly when SBO occurs. Consequently, only the primary system of the simplified BWR model, with the appropriate boundary conditions, is needed in order to perform the transient simulations. Although highly simplified, this case is quite similar to what happened in Fukushima Daiichi Unit 1. Unit 1 had no RCIC system, while the isolation condenser system was believed not to be functioning or only available for a very short period of time during the accident. Therefore, the Unit 1 reactor core reached a fuel failure temperature only a few hours into the accident. Figure 6 shows the schematics of the simplified BWR plant system modeled for this scenario.

Steady-state simulation results for this scenario were obtained by marching transient solutions sufficiently for long times so that no further local changes occurred. The main steam line isolation valve

and the feedwater line valve were kept open during the steady-state simulations. Figures 7 through 9 show the steady-state results for Scenario I.

Figure 7 shows the calculated void fraction (vapor volume fraction) in the reactor core (the bottom line) and the in the steam separator stand pipe (the top line). The void fraction is zero when the subcooled coolant enters the reactor core inlet. The coolant starts to boil and the void fraction increases as the coolant flows upward in the core, while heat is continuously added to the coolant.

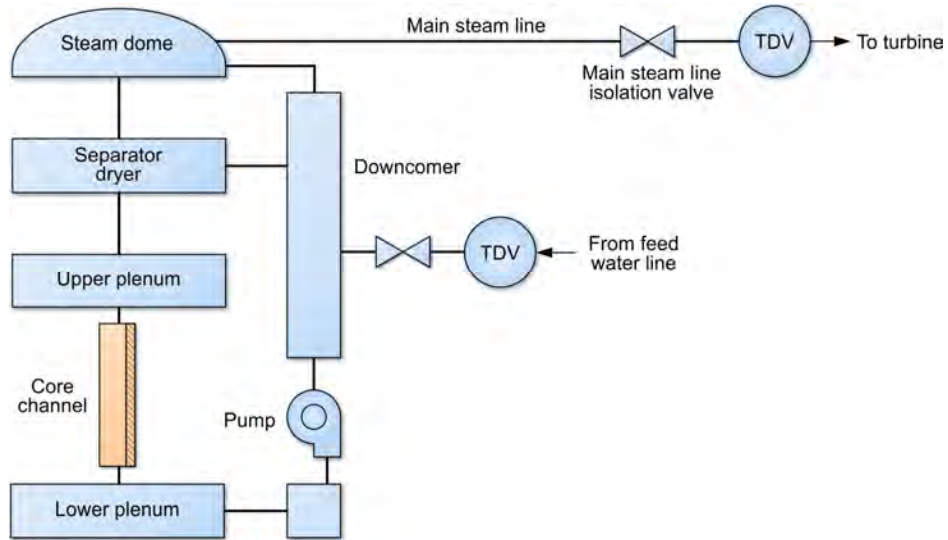

Figure 6. Schematics for boiling water reactor station blackout simulation – Scenario I.

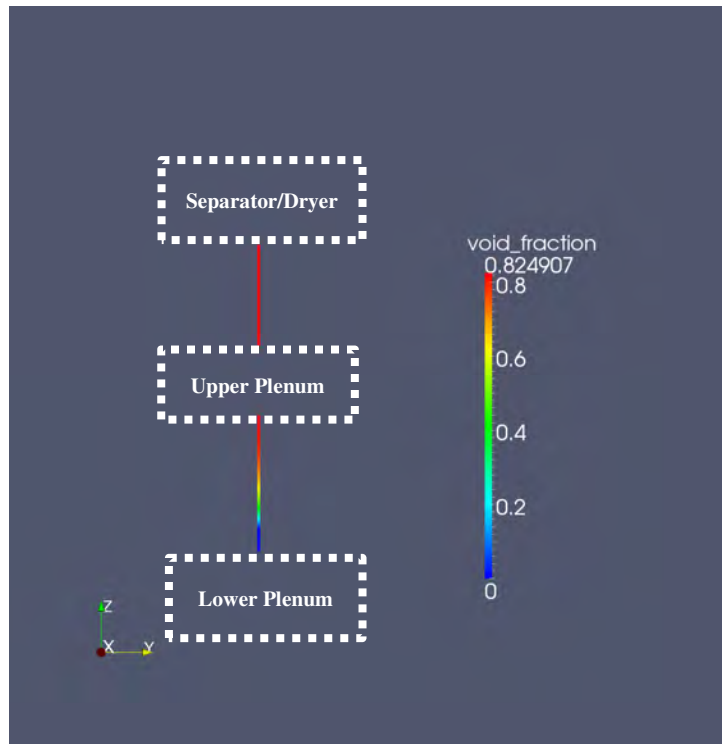

Figure 7. RELAP-7 calculated void fraction distribution in the reactor core (the bottom line) and the separator stand pipe (the top line) at steady-state for Scenario I.

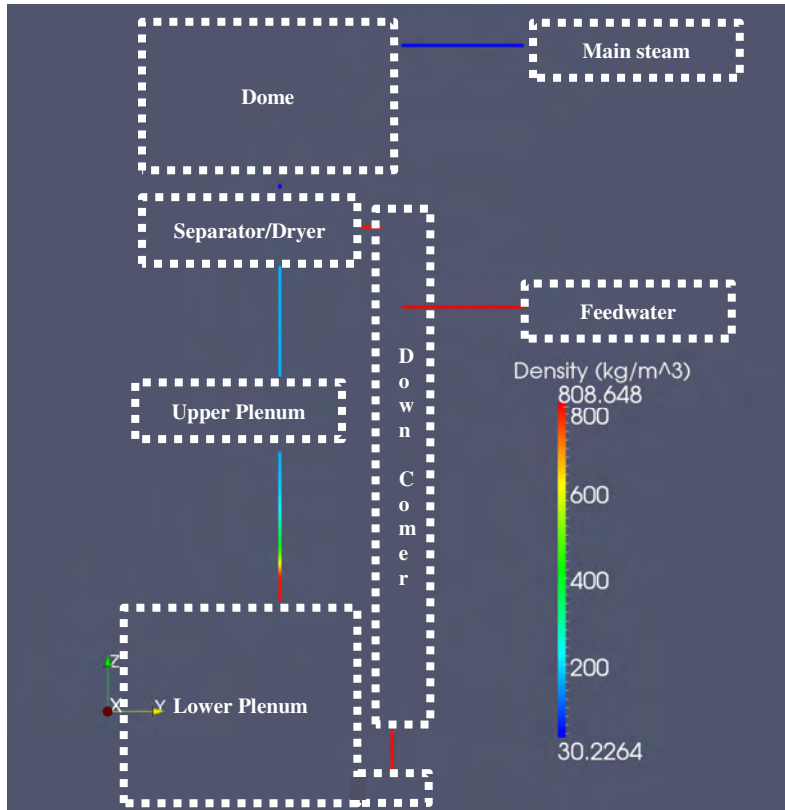

Figure 8. RELAP-7 calculated fluids density at steady-state for Scenario I.

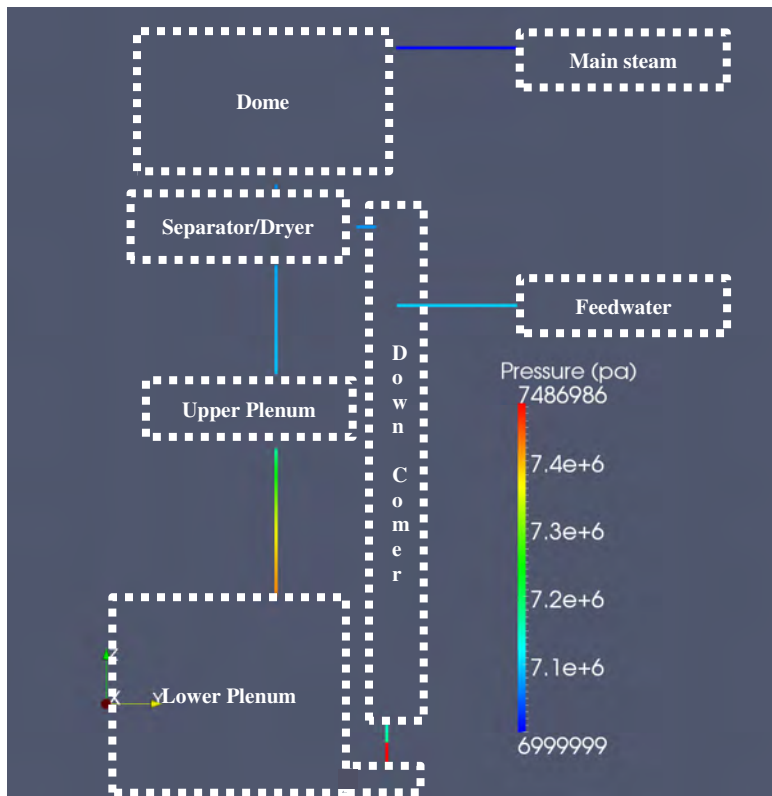

Figure 9. RELAP-7 calculated pressure distribution at steady-state for Scenario I.

Figure 8 shows the computed fluid density for the simplified BWR primary system. The fluid density is the highest at the feedwater line and the down comer pipe that feeds water into the lower plenum of the reactor vessel. The fluid density decreases continuously as the fluid flows upward through the reactor core and absorbs heat from the fuel. The fluid density is lowest in the main steam line.

Figure 9 displays the RELAP-7 calculated pressure distribution for the simplified BWR primary system. Pressure is highest in the pipe that connects to the primary pump outlet with the lower plenum.

Using the restart capability of RELAP-7, (after the steady-state results were obtained), the SBO transient runs were initiated. The RELAP-7 transient simulations were driven with the RAVEN code. During the SBO transient simulations, the main steam line valve was kept open while the feedwater line valve was closed to simulate the extreme situation of no safety injection of the makeup cooling water during SBO. Figure 10 shows the evolution of the down comer liquid level during the SBO simulation. The down comer liquid level indicates the coolant inventory within the reactor vessel. Without makeup water from the safety injection system, the liquid level in the down comer gradually decreased as the SBO accident progressed. The decreasing liquid level resulted in less driving head. Consequently, natural circulation capability is degraded within the reactor core to drive the coolant through the reactor core and to transport the heat out of the reactor core.

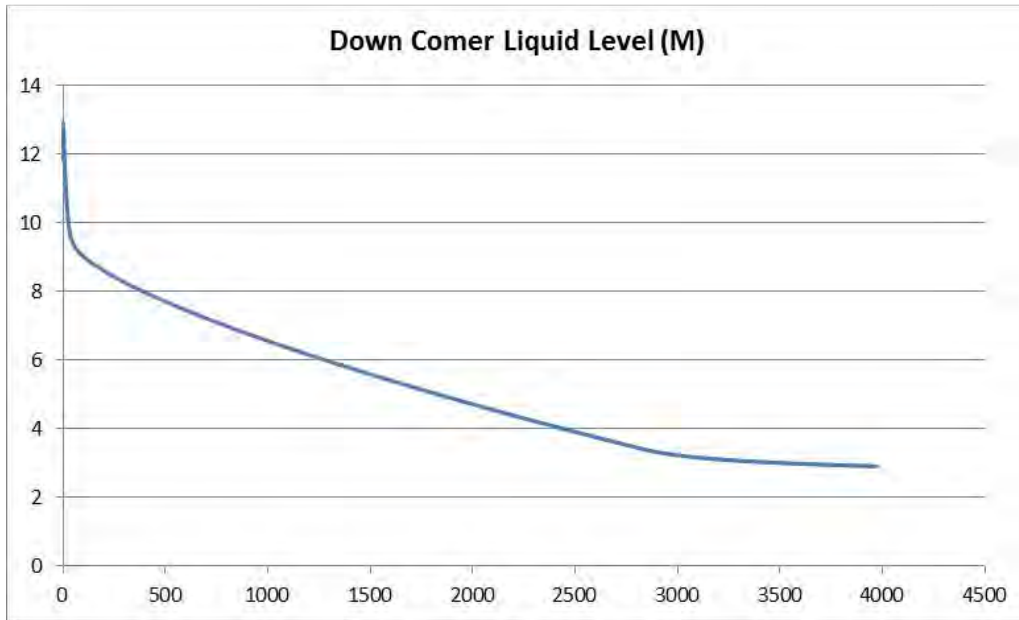

Figure 10. RELAP-7 calculated down comer liquid level during station blackout for Scenario I.

Figure 11 shows the computed peak clad temperature for this SBO simulation, including a comparison with the MELCOR SBO calculation done for Peach Bottom as part of NUREG-1953 [5]. As can be seen in the figure, close agreement with the general trend and the point at the onset of core damage occurs is seen between the two analyses. The reactor core was uncovered and dry out occurred at about 45 minutes after the SBO was initiated. It can be seen that the peak clad temperature decreased relative to the steady-state value before the dry out occurred. However, the peak clad temperature value increased rapidly after the dry out phenomenon occurred. The simulation was terminated after more than an hour because the peak clad temperature already exceeded the Nuclear Regulatory Commission's 10 CFR 50.46 specified value of 1,477.6 K (2,200 F). Figure 12 shows the fluids density distribution at the end of the SBO simulation. Figure 13 shows the fluids velocity at the end of the SBO simulation. Figure 14 shows

the vapor volume fraction (void fraction) distribution in the reactor core and in the separator stand pipe at the end of the SBO simulation.

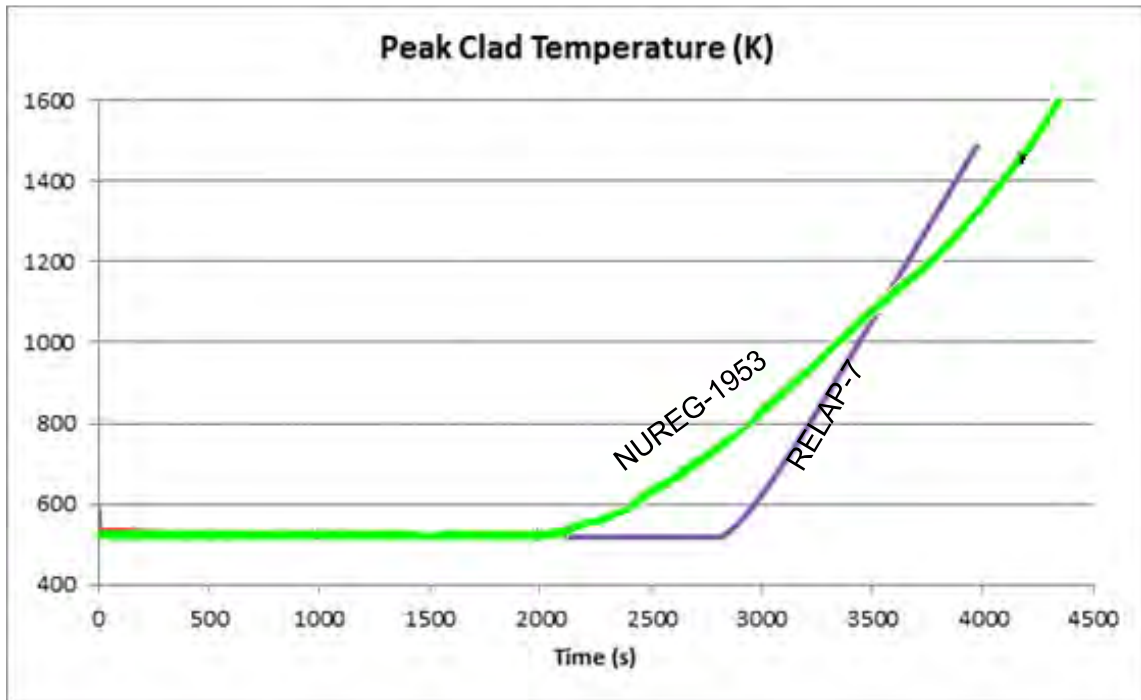

Figure 11. RELAP-7 calculated peak clad temperature during station blackout for Scenario I.



Figure 12. RELAP-7 calculated fluids density at the end of simulation for Scenario I.

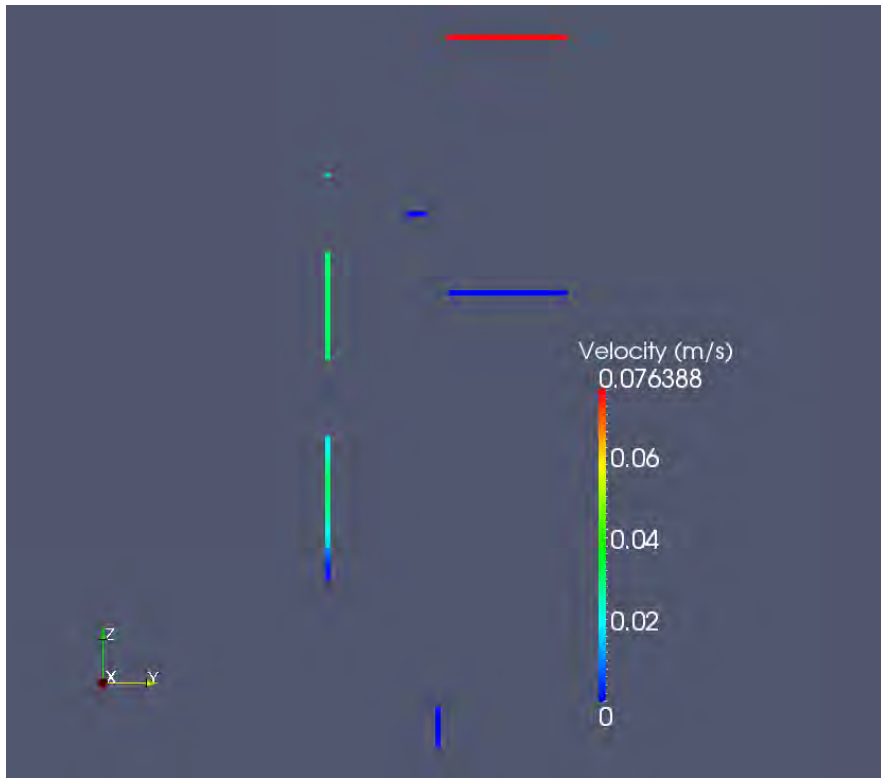

Figure 13. RELAP-7 calculated fluids velocity at the end of simulation for Scenario I.

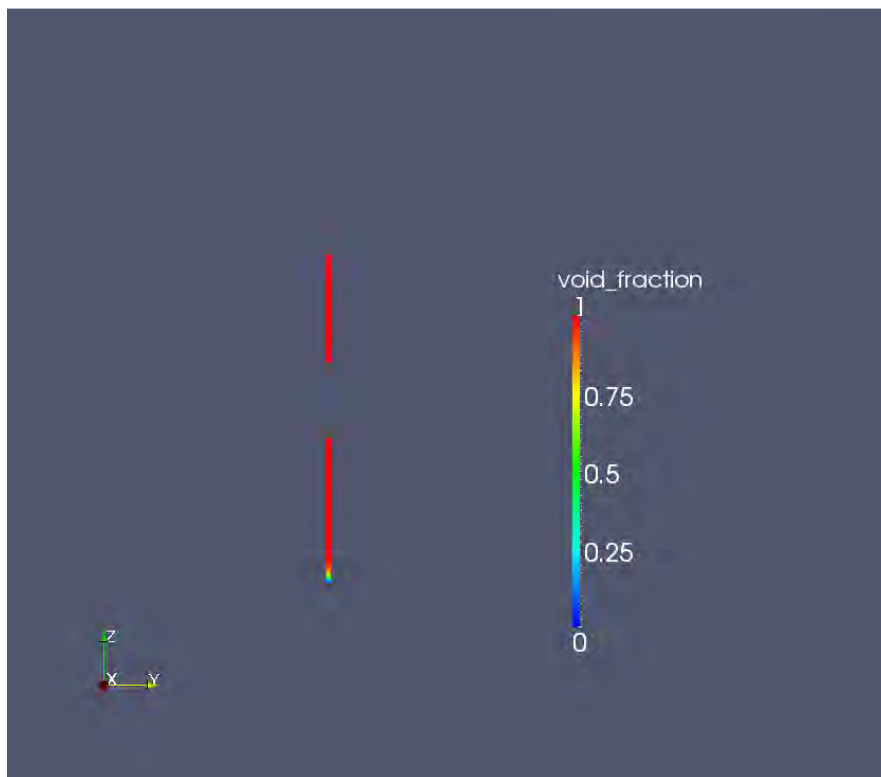

Figure 14. RELAP-7 calculated fluids void fraction in the core (the bottom line) and in the separator stand pipe (the top line) at the end of simulation for Scenario I.

4.2 Simulation Results for Station Blackout Scenario II – Fully Coupled Reactor Core Isolation Cooling Safety Injection System

This scenario is a more probable representation of what would happen in a BWR SBO scenario with an RCIC system functioning similar to what had happened in Fukushima Daiichi Units 2 and 3. In this scenario, when SBO occurs, the steam-driven RCIC turbine would drive the RCIC pump to withdraw cooling water from the suppression pool and inject it into the reactor core. In the simulations, the RCIC system was turned on and off for three periods until battery energy was exhausted. Then the turbine was kept on to simulate the pressure release through the safety relieve valve (the safety relieve valve model will be available in the next milestone report) and the makeup water through the RCIC pump is shutdown. The reactor water level gradually decreased due to the loss of the water inventory in the suppression pool. Dry out happened after the down comer water level became very low. The peak fuel clad temperature rapidly increased after dry out. The simulation stopped when the water level in downcomer drops to zero and the peak clad temperature approached Nuclear Regulatory Commission's 10 CFR 50.46 specified value of 1,477.6 K (2200 F). Three pressure release and makeup water supply strategies were simulated.

The simulation models include all the components for the Scenario I and additional systems for the main steam line isolation valve, main feed water line shutdown valve, RCIC system steam line, RCIC makeup water line, wet well, and a non-condensable gas line with a closed vacuum breaker connected to the dry well. The schematics for this simulation are shown in Figure 4. More than 40 components were used to simulate the whole system. Twelve types of components were used, including reactor, volume branch, core channel, pipe, separator dryer, valve, time dependent volume, turbine, ideal pump, wet well, down comer, and pump. Figure 15 shows the steady-state pressure distribution in the system. It is noted that in the simulation, the high pressure system (in red) is separated from the low pressure system (in blue) by the RCIC turbine and pump.

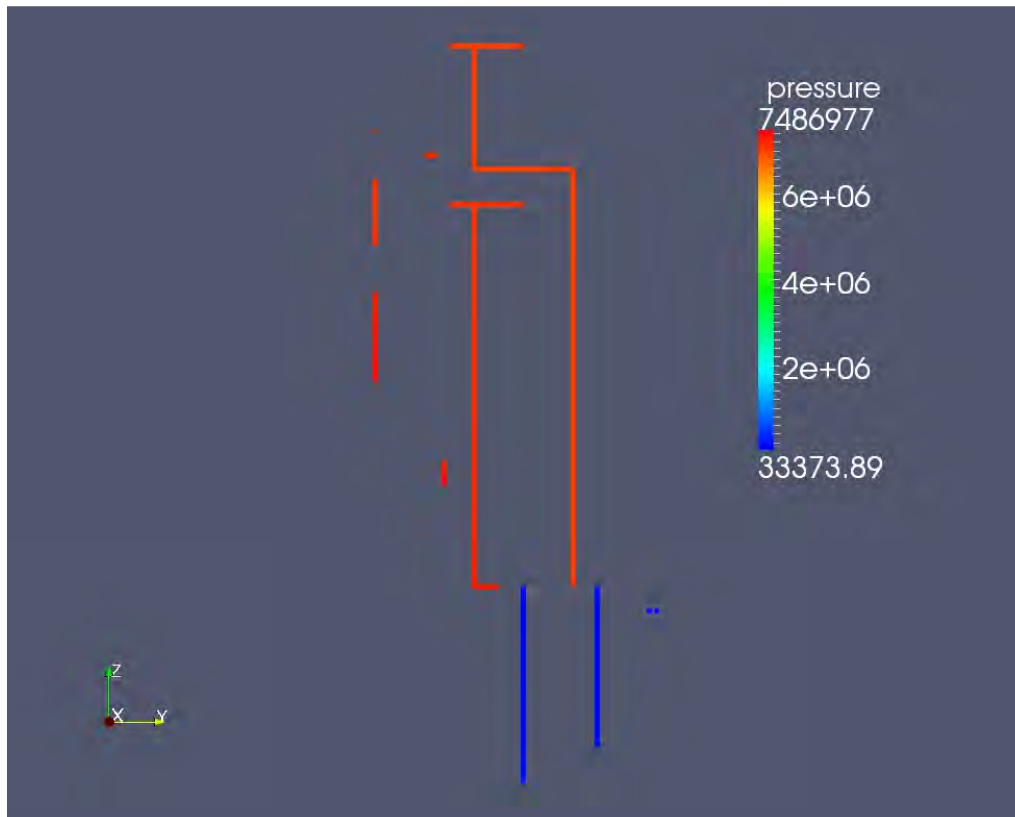

Figure 15. Steady-state pressure distribution for Scenario II.

The simulation sequence for the base case scenario is summarized as follows:

- At $t = 0$ second, SBO initiating event occurred:
 - Reactor scrammed
 - Decay heat was turned on
 - Primary pump coast down started with half-time of 1 second
- At $t = 1$ second:
 - Feedwater line valve began to close and became fully closed at $t = 2$ second
 - Main steam isolation valve began to close and became fully closed at $t = 11$ second
- From $t = 10$ second to 7,270 second, the RCIC system was turned on and off for three periods with a transition time of 10s between all the changes of status
 - 1st period of turning on RCIC system for 30 minutes (same mass flow rate at 40 kg/s for steam release through RCIC turbine as water injection through RCIC pump)
 - 1st period of turning off RCIC system for 15 minutes
 - 2nd period of turning on RCIC system for 30 minutes (mass flow rate at 40 kg/s)
 - 2nd period of turning off RCIC system for 15 minutes
 - 3rd period of turning on RCIC system for 30 minutes (mass flow rate at 20 kg/s)
- From $t = 7,270$ second and on, maintained pressure release through turbine with mass flow rate at 20 kg/s and shut off makeup water supply through the RCIC pump
- At $t = 22,937$ second, simulation stopped when the peak clad temperature approached 1477.6 K.

A similar control sequence was used by the Electric Power Research Institute with the MAAP code [6] to simulate a BWR SBO. However, the RELAP-7 simulations presented here represent the first-of-a-kind simulation capability with fully coupled RCIC safety system. The pre-determined control procedures were used in our simulations. The simulations can be further improved by implementing the dynamical control using the reactor pressure and water level signals. This capability will be available in the future simulations when the safety relieve valve component is developed to control system pressure.

Figure 16 shows the pressure distribution at the end of the simulation. We note that there are three different pressure regions: the red region is for the isolated secondary side with steady-state conditions, the green region is for the primary system at pressure around 4 MPa, and the blue region is for the steam injection line, makeup water line, and dry-well release line connected to the wet well. Figure 17 shows the fluid temperature distribution. Note that the very high temperature at the upper core region indicates core dry out and fuel damage. Figure 18 shows the fluid density in the system. It clearly shows that steam fills the majority of the reactor core.

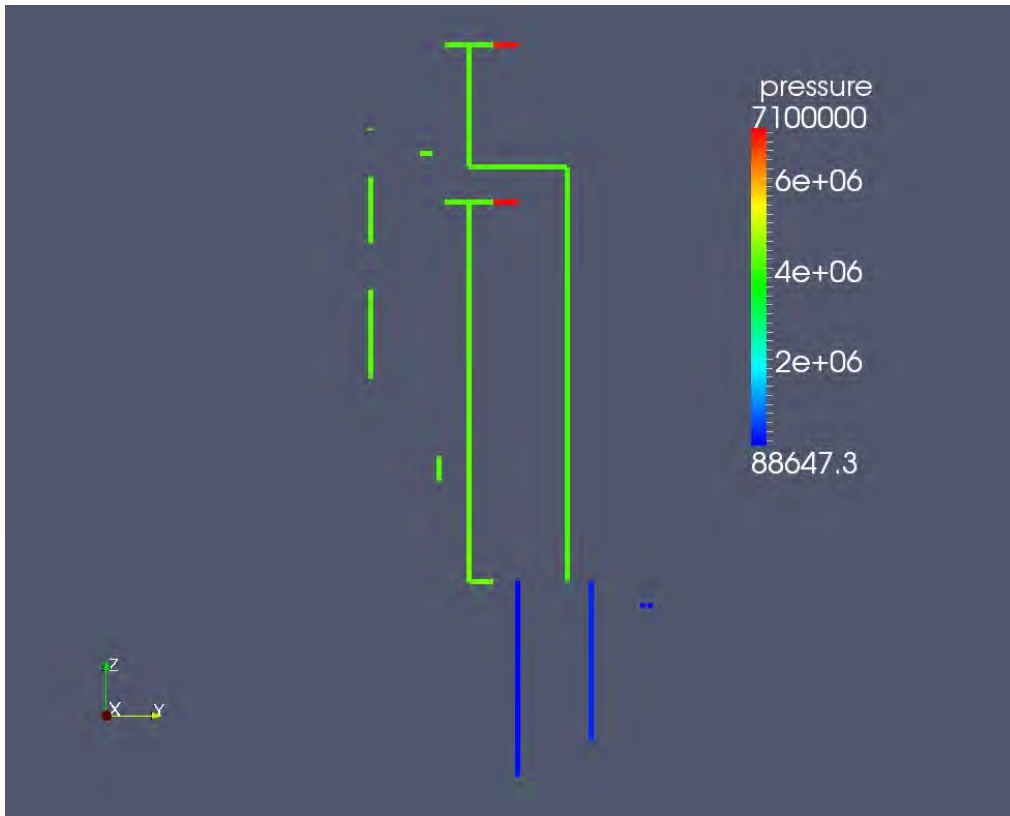

Figure 16. RELAP-7 calculated pressure distribution at $t = 22937$ s for the Scenario II base case.

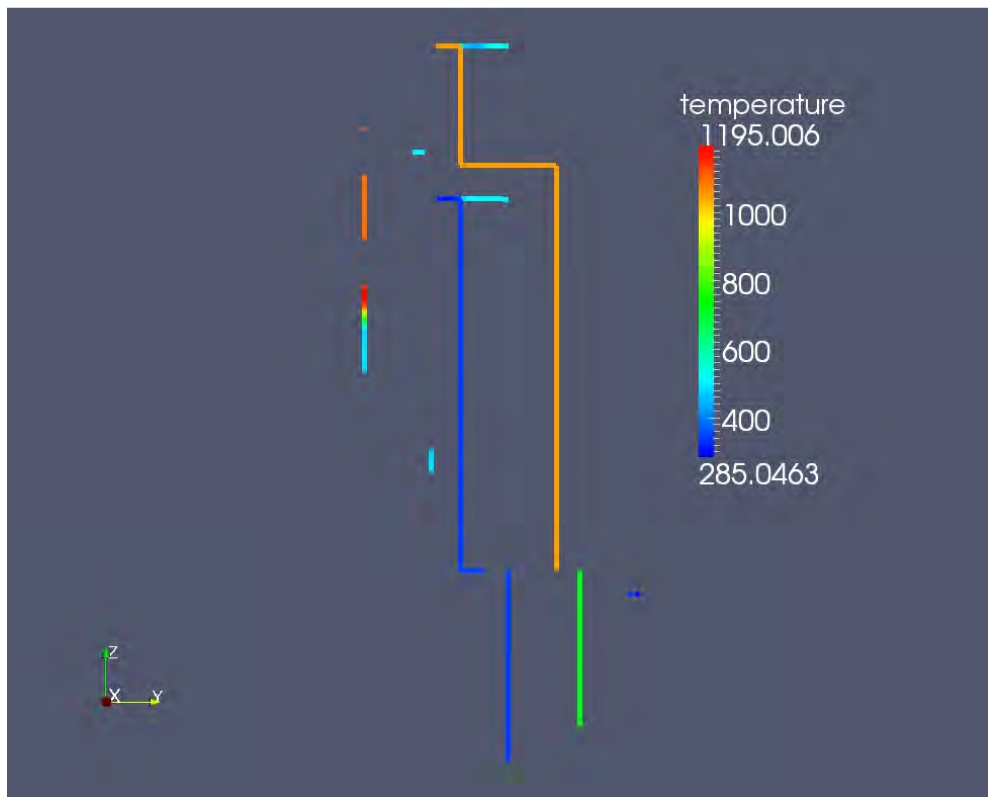

Figure 17. RELAP-7 calculated temperature distribution at $t = 22937$ s for the Scenario II base case.



Figure 18. RELAP-7 calculated fluid density distribution at $t = 22937$ s for the Scenario II base case.

Time evolutions of key system parameters are shown in Figures 19 through 25. Figure 19 shows the turbine shaft work calculated by RELAP-7 during the transient. We can see that the first two RCIC on/off periods are clearly identifiable from the figure. The RCIC turbine shaft work (or turbine power) was dynamically determined by the plant operational conditions, including inlet stagnation pressure and temperature and outlet pressure. When the turbine nominal mass flow rate was ramped up (using the turbine control valve), both the shaft work and real mass flow rate increased quickly. The reactor vessel pressure decreased with time (as shown in Figure 20) due to the releasing of steam through the turbine into the suppression pool. The turbine power decreased along with the decreasing reactor vessel pressure. The turbine dynamical behavior was well captured by the new turbine model. This is a major improvement over current SBO simulations, where a given mass flow rate is typically used to simulate the turbine behavior. During extended SBO accidents (as demonstrated in the Fukushima Daiichi accidents), major instruments are not available. The turbine mass flow rate and power should not be guessed, but should be directly simulated through dynamical models such as the ones presented in this report.

Figure 20 shows the reactor vessel pressure. Generally, when the RCIC system is on, the vessel pressure would decrease with time due to pressure release through the RCIC turbine and cold water injection through the RCIC pump. When the RCIC system is off, the pressure would increase with time. After the makeup water injection was turned off, the reactor vessel pressure increased initially then began to decrease because the decay heat power drops to a lower level with time. It should be noted that it is not an efficient way to control reactor pressure through the RCIC system. Instead, the pressure relieve valve should be used to rapidly reduce system pressure, which will be added in the next step of our simulation work.

Figure 21 shows the down comer water level during the transient. The down comer water level is the major parameter for natural circulation to drive coolant through the reactor core. It is also indicative of the total water inventory within the reactor vessel. With the RCIC system fully functioning, the water level can be well maintained within a couple of meter range. When the safety water injection was lost, the level began to steadily drop.

Figure 22 shows the peak clad temperature during the transient. The peak clad temperature decreased when the RCIC system was on and increased during off time. When the RCIC system makeup water injection stopped, the peak clad temperature changed slowly with the system pressure until dry out occurred. Then the peak clad temperature increased very quickly.

Figure 23 shows the wet well suppression pool average water temperature. This is an important parameter to determine the available net positive suction head (NPSHa) and the availability and performance of the RCIC pump. The water temperature rose by 41 K from the steady state value of 300 K. The conservative value for the pool temperature limit (373 K) is the boiling temperature at atmospheric pressure.

Figure 24 shows the wet well suppression pool level evolution during the transient. The initial level was set at 4 m and the final level was computed to be 4.72 m, which represents a nearly 20% increase due to steam injection into the suppression pool and its heat up.

Figure 25 shows the wet well gas pressure, which also is an important parameter to determine the NPSHa value. The gas pressure only increased by about 40% from the initial value, while the vacuum breaker typically was set to open at a much higher pressure difference. Therefore, in this simulation, there was no pressure release to the dry well.

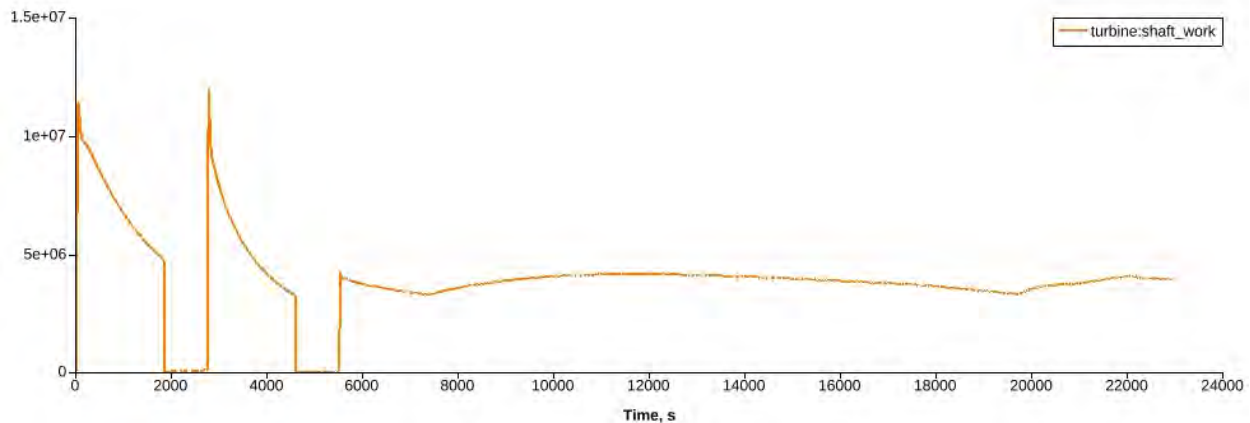

Figure 19. Reactor core isolation cooling turbine shaft work for the Scenario II base case.

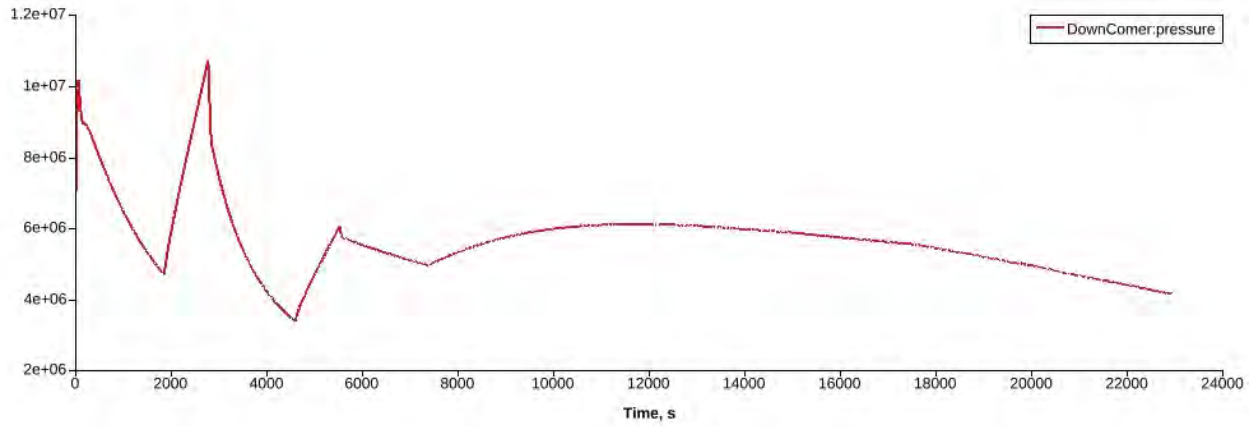

Figure 20. Reactor vessel pressure for the Scenario II base case.

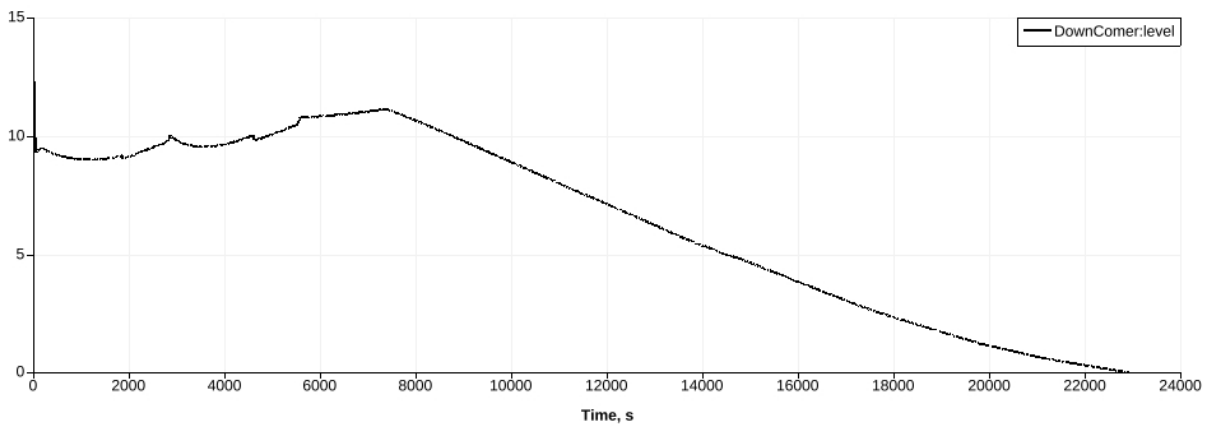

Figure 21. Down comer water level for the Scenario II base case.

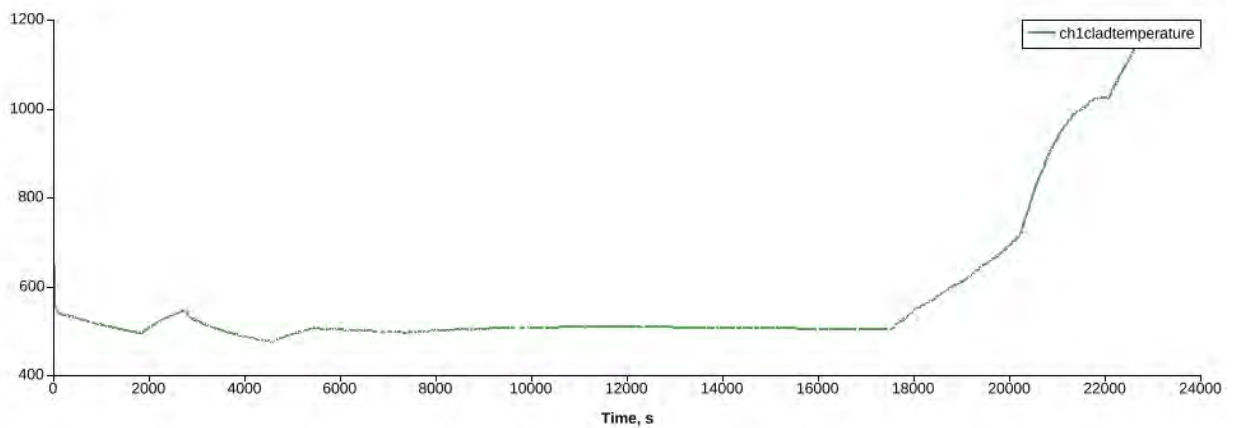

Figure 22. Peak clad temperature for the Scenario II base case.

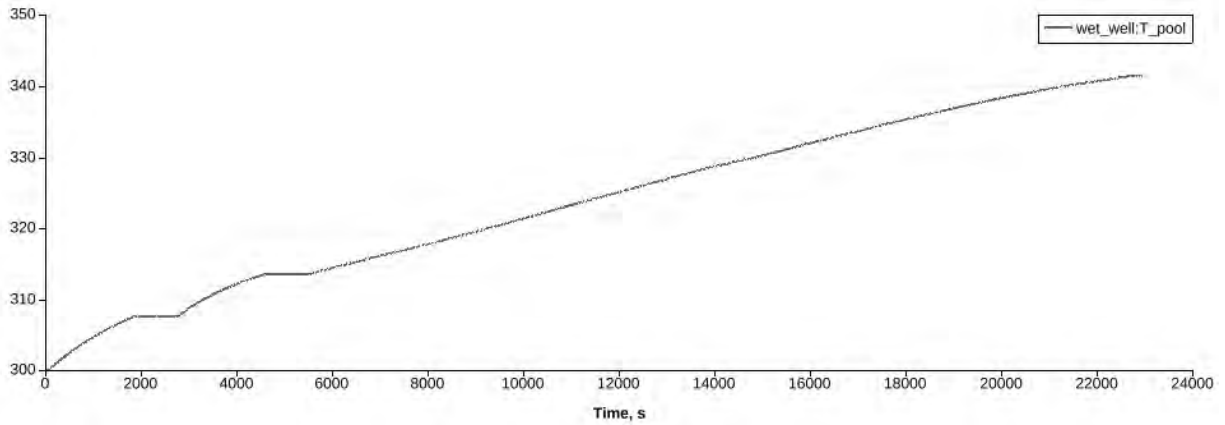

Figure 23. Wet well pool temperature for the Scenario II base case.

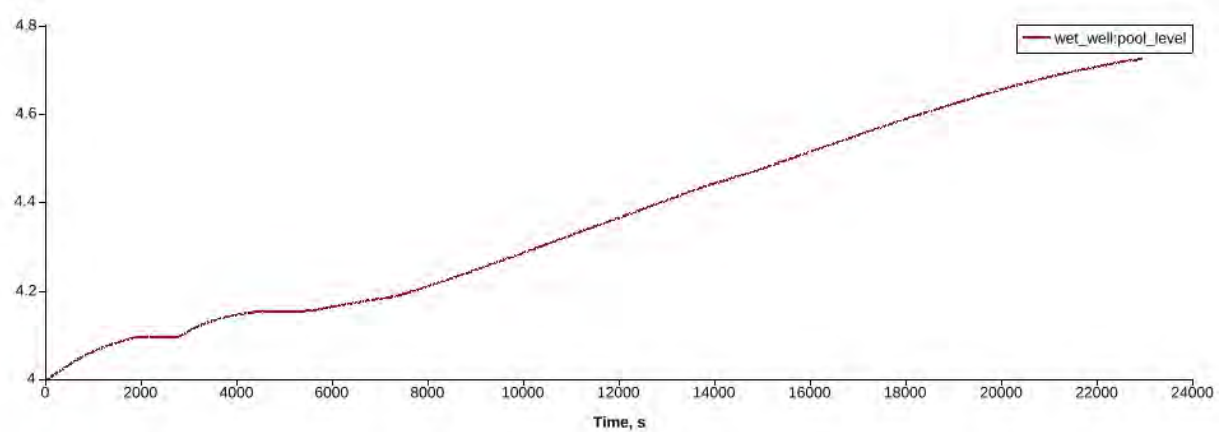

Figure 24. Wet well pool level for the Scenario II base case.

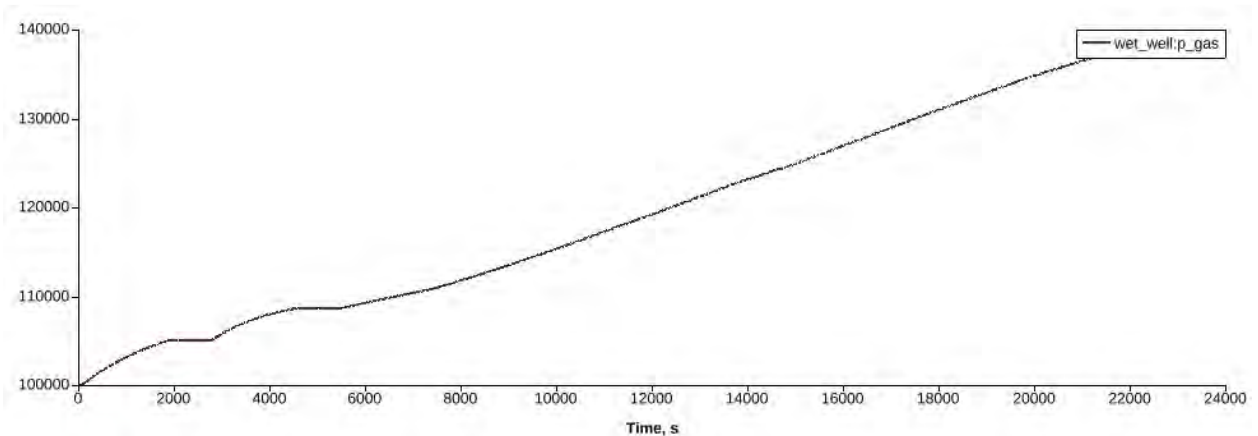

Figure 25. Wet well gas space pressure for the Scenario II base case.

To investigate different RCIC control strategy effects on the accident transients, two more scenarios were considered: one with a larger mass flow rate and one with a smaller mass flow rate through the RCIC system. The accident sequence for the larger mass flow rate case was almost identical as the base case, except for different mass flow rates used for different periods: 50 kg/s for the RCIC system first period; 40 kg/s for the second period; and 30 kg/s for the third period. Figure 26 shows the

turbine shaft work for this case. Note that there are different turbine power levels for the three periods. Figure 27 shows the reactor vessel pressure. Because of the larger steam release rate through the RCIC turbine, the pressure was much lower than the base case (see Figure 20), except for the initial accident stage. Figure 28 shows the water level in the down comer. Comparing to the base case (Figure 21), more cold water was injected into the reactor vessel. Because of this, the dry out time was delayed to 20,332 s (47-minute delay relative to the base case).

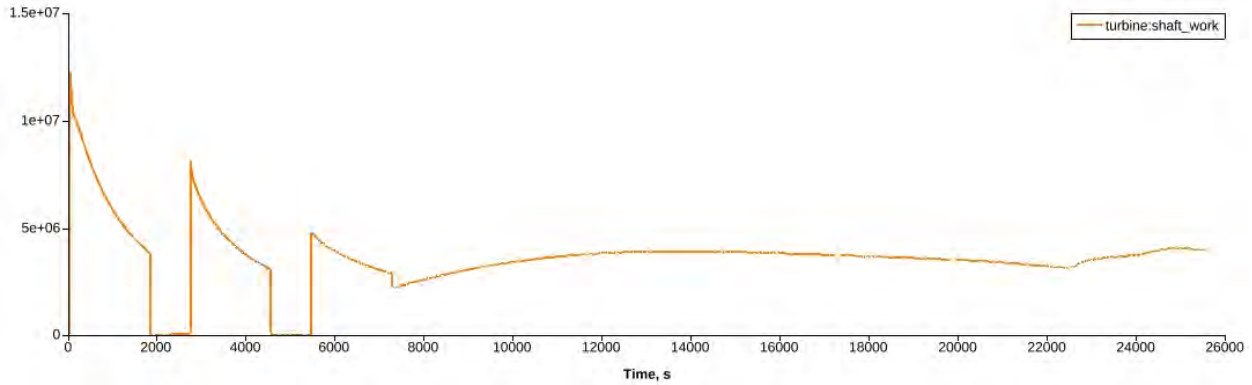

Figure 26. Turbine shaft work for Scenario II with larger reactor core isolation cooling flow rate.

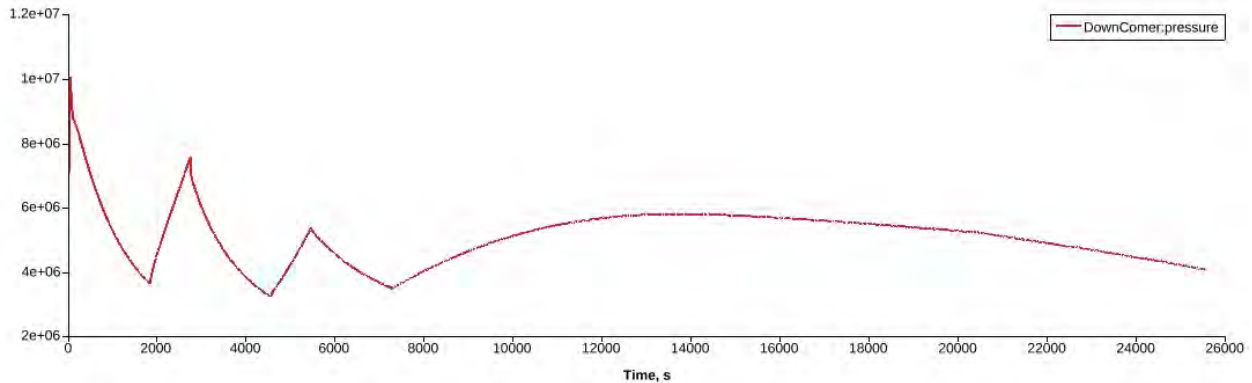

Figure 27. Reactor vessel pressure for Scenario II with larger reactor core isolation cooling flow rate.

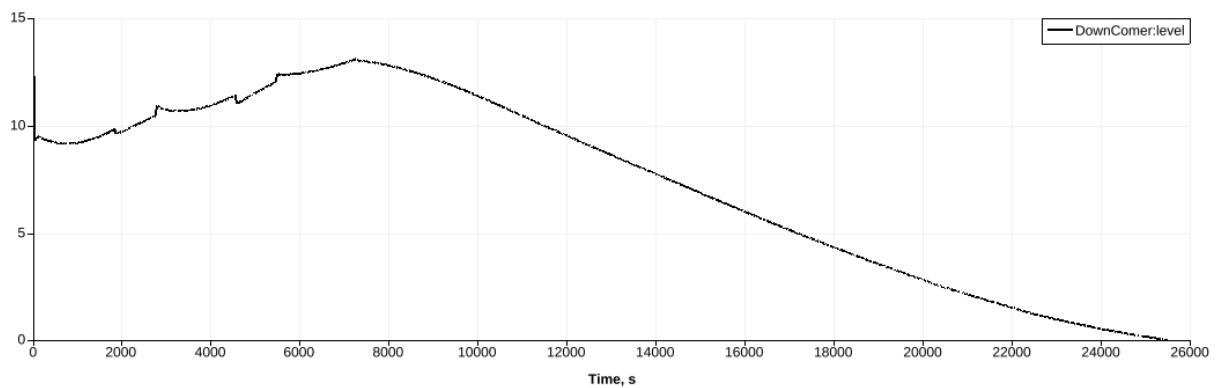

Figure 28. Down comer water level for Scenario II with larger reactor core isolation cooling flow rate.

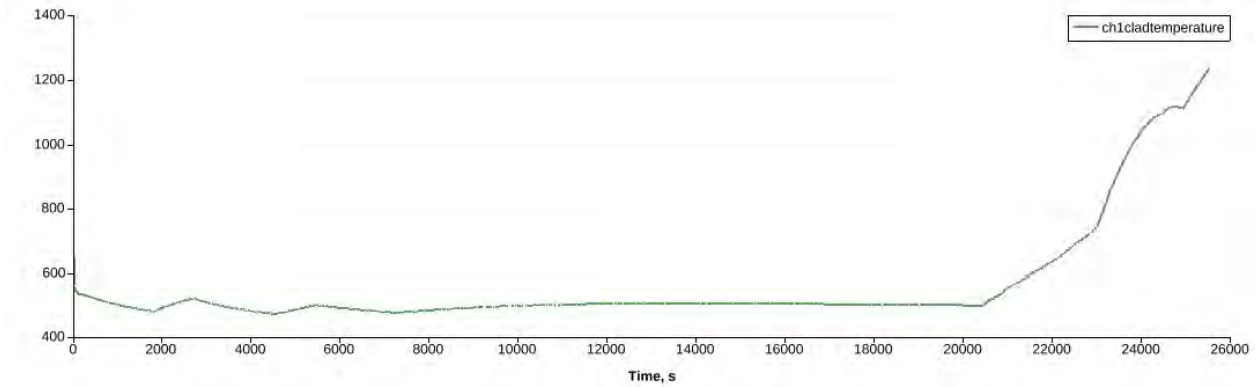

Figure 29. Peak clad temperature for the Scenario II with larger reactor core isolation cooling flow rate .

The accident sequence for the smaller mass flow rate case used not only different mass flow rates for different periods but with different on/off time: 30 kg/s for RCIC system first period (40 minutes on and 5 minutes off); 30 kg/s for the second period (40 minutes on and 5 minutes off); and 30 kg/s for the third period (40 minutes on). Figures 30 through 33 show the results for this case, which are similar to the base case, except for lower pressure as shown in Figure 31. The dry out happened at about 18,300 s, which is slightly later than that of the base case at 17,400 s.

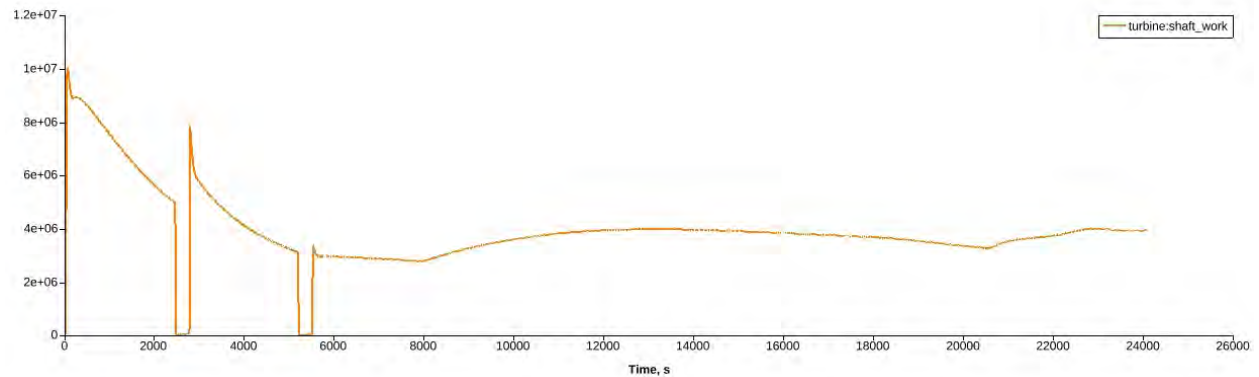

Figure 30. Turbine shaft work for Scenario II with lower reactor core isolation cooling flow rate.

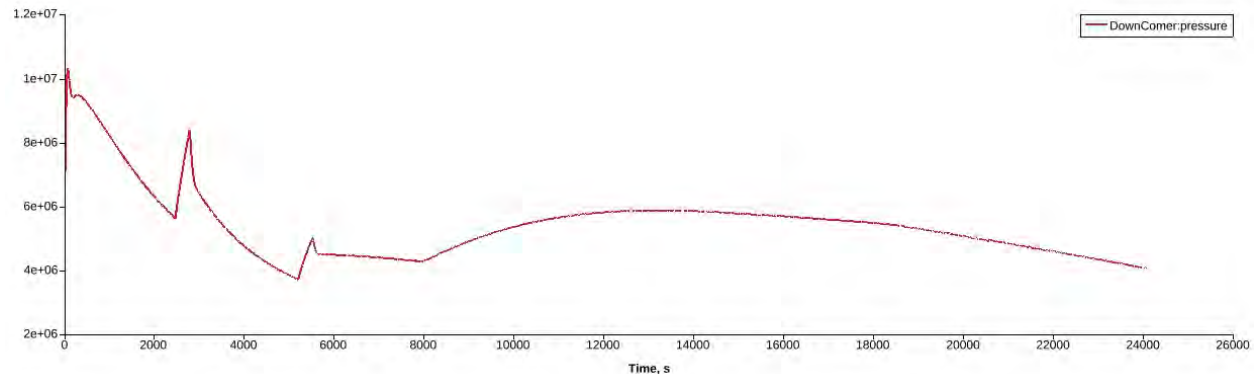

Figure 31. Reactor vessel pressure for Scenario II with lower reactor core isolation cooling flow rate.

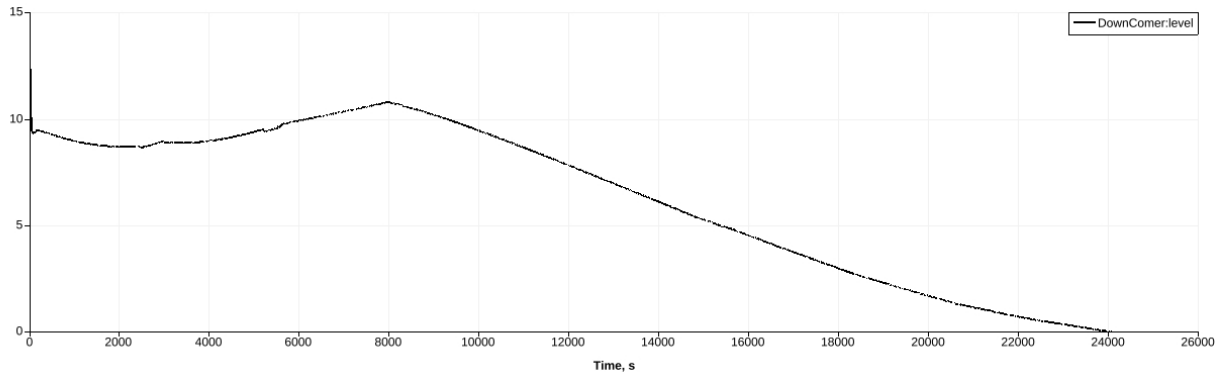

Figure 32. Down comer water level for Scenario II with lower reactor core isolation cooling flow rate.

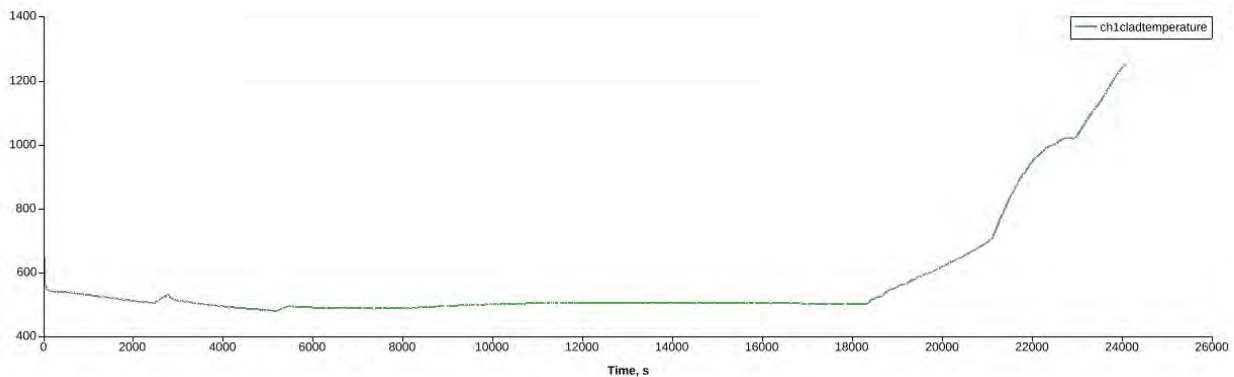

Figure 33. Peak clad temperature for Scenario II with lower reactor core isolation cooling flow rate.

5. CONCLUSION AND FUTURE WORK

The RELAP-7 code has been developed to successfully perform BWR transient simulations with simplified geometries under SBO scenarios. The fully coupled reactor core isolation cooling system simulation capability represents the first-of-a-kind capability and will provide more accurate SBO simulations upon further RELAP-7 developmental maturation.

Even though many significant accomplishments have been achieved, additional research and development remains to be done. The previous RELAP-7 milestone report [2] contains a detailed discussion on future development needs. This discussion of future work focuses primarily on near-term development activities to fulfill the long-term goal of RELAP-7. The major focus of the RELAP-7 code development during FY 2014 includes demonstrating BWR SBO analyses on realistic plant geometries and providing a “technical theory” document describing the science behind the software development. The following paragraphs discuss the main development needs for FY 2014.

RELAP-7 has been developed so far using stiffed gas equation of state modified for use with nonequilibrium two-phase flow calculations. Because it was fit over a very large temperature range, discrepancies are observed for the saturation temperature for a given pressure between the calculated values versus the reference values using the data from International Association for the Properties of Water and Steam [7]. Therefore, the properties such as the International Association for the Properties of Water and Steam should be implemented into RELAP-7 in FY 2014.

Another area of improvement to be addressed is the stabilization scheme associated with using the continuous finite element method. Thus far, the streamline upwind/Petrov-Galerkin and Lapidus

stabilization methods have been implemented into RELAP-7. However, streamline upwind/Petrov-Galerkin is not an ideal choice for two-phase flow models and Lapidus cannot eliminate the oscillations in the solutions. Hence, future work will include implementing more robust stabilization methods (e.g., the flux corrected transport method and the entropy viscosity method).

The third area of improvement involves addition of more realistic closure models for the seven-equation, two-phase flow model as well as modifications to speed up its execution for simulations such as BWR SBO. The seven-equation, two-phase flow model is different from the commonly used, two-fluid, six-equation models of existing safety analysis codes. Although many of the closure models used in the existing codes can be adapted for the seven-equation model, some additional model developments are needed to fully support the seven-equation model. It is expected that the closure models will be developed for selected flow regimes (such as bubbly flow). A complete set of closure models for the important two-phase flow regimes must be implemented and validated before RELAP-7 can predict safety transients with much reduced uncertainty (from that of existing codes).

6. REFERENCES

1. *RELAP-7 Level 2 Milestone Report: Demonstration of a Steady State Single Phase PWR Simulation with RELAP-7*, INL/EXT-12-25924, Idaho National Laboratory, May 2012.
2. *RELAP-7: Demonstrating Seven-Equation, Two-Phase Flow Simulation in a Single Pipe, Two-Phase Reactor Core and Steam Separator/Dryer*, INL/EXT-13-28750, Idaho National Laboratory, April 2013.
3. *Deployment and Overview of RAVEN Capabilities for a Probabilistic Risk Assessment Demo for a PWR Station Blackout*, INL/EXT-13-29510, June 2013.
4. “Boiling Water Reactor Turbine Trip (TT) Benchmark”, Volume I: Final Specifications, NEA/NSC/DOC (2001) 1.
5. *Confirmatory Thermal-Hydraulic Analysis to Support Specific Success Criteria in the Standardized Plant Analysis Risk Models – Surry and Peach Bottom*, NUREG-1953, May 2011.
6. S. M. Hess and D. Dube, “Key Parameters for Risk-Informed Management of Safety Margins: BWR EPU, Station Blackout Scenario”, a presentation made on July 30, 2013 at an INL/EPRI RISMIC Coordination Meeting.
7. W. Wager and A. Pruss, “The IAPWS Formulation 1995 for the Thermo- dynamic Properties of Ordinary Water Substance for General and Scientific Use,” 2002.

Appendix A: Input Files for SBO Scenario II Base Case

RAVEN/RELAP-7 transient input file:

```
[GlobalParams]

model_type = 32

# these initial values will be used for all the fluid models and will be overrode by local initial values if provided
# if not provided, these default values will be used
global_init_P = 7.e6
global_init_V = 3.
global_init_T = 517.
global_init_alpha = 0.0

# scaling factors for flow equations; if not provided, default values will be used
scaling_factor_var = '1e-3 1e-4 1e-8'
temperature_sf = '1e-4'
gravity = '0 0 -9.8'
stabilization_type = 'LAPIDUS'
[]

[EoS]

[./two_phase_eos]
type = TwoPhaseStiffenedGasEOS
[../]

[./vapor_phase_eos]
type = StiffenedGasEquationOfStateVapor
[../]

[./liquid_phase_eos]
type = StiffenedGasEquationOfStateLiquid
[../]

[./eos_nc]
type = N2Properties
[../]

[] # close EoS section

[Functions]
[./decayheatcurve]
type = PiecewiseLinear
x = '0.0 0.1 0.2 0.3 0.4 0.5 0.6 0.7 0.8 0.9 1.0 1.5 2.0
    3.0 4.0 5.0 6.0 8.0 10.0 15.0 20.0 30.0 40.0 50.0 60.0 80.0
    100.0 125.0 150.0 200.0 300.0 400.0 500.0 600.0 800.0 1000.0 1250.0 1500.0 2000.0
    2500.0 3000.0 3500.0 4000.0 5000.0 6000.0 7000.0 8000.0 9000.0 10000.0 15000.0 20000.0 800000.0'
y = '1.0 0.8382 0.572 0.3806 0.2792 0.2246 0.1904 0.1672 0.1503 0.1376 0.1275 0.1032 0.09884
    .09209 .0869 .08271 .07922 .07375 .06967 .06251 .05751 .05060 .04591 .04246 .03977 .03604
    .03357 .03145 .02997 .02798 .02565 .02418 .02307 .02217 .02073 .01959 .01844 .01749 .01600
    .01489 .01401 .01331 .01274 .01185 .01118 .01067 .01025 .009895 .009596 .008553 .007902 2.31e-3'
[../] # close Functions section

[Materials]
[./fuel-mat]
```

```

type = SolidMaterialProperties
k = 3.7
Cp = 3.e2
rho = 10.42e3
[../]
[./gap-mat]
type = SolidMaterialProperties
k = 0.7
Cp = 5e3
rho = 1.0
[../]
[./clad-mat]
type = SolidMaterialProperties
k = 16
Cp = 356.
rho = 6.551400e3
[../]
[]

```

[Components]

```

[./reactor]
type = Reactor
initial_power = 3293.0e6
decay_heat = decayheatcurve
[../]

```

```

[./lowerplenum]
type = VolumeBranch
eos = two_phase_eos
center = '0.0 0.0 2.64'
inputs = 'pipe11(out)'
outputs = 'ch1(in)'
K = '1.0 20'
volume = 61.48
Area = 11.64
initial_T = 517.0
scale_factors = '1.0E-3 1.0E-9 1.0E-0' # rho, rhoE, vel
[../]

```

```

[./ch1]
type = CoreChannel
eos = two_phase_eos
position = '0 0.0 5.28'
orientation = '0 0 1'
A = 7.8
Dh = 1.3597E-02
#length = 3.6576
length = 3.66
n_elems = 50 #200
f = 0.2
Hw = 1.0e4
aw = 2.354927e2
Ts_init = 517.
fuel_type = cylinder
dim_hs = 1
n_heatstruct = 3

```



```
name_of_hs = 'FUEL GAP CLAD'  
width_of_hs = '6.057900e-3 1.524000e-4 9.398000e-4'  
elem_number_of_hs = '5 1 2'  
material_hs = 'fuel-mat gap-mat clad-mat'  
power_fraction = '1.0 0.0 0.0'  
stabilization_type = 'NONE'  
model_type = 32  
[../]
```

```
[./upperplenum]  
type = VolumeBranch  
eos = two_phase_eos  
center = '0.0 0.0 9.88'  
inputs = 'ch1(out)'  
outputs = 'pipe6(in)'  
K = '3.0 1.0'  
volume = 26.99  
Area = 14.36  
initial_T = 517.0  
scale_factors = '1.0E-3 1.0E-8 1.0E-0'  
[../]
```

```
[./pipe6] # rising pipe  
type = Pipe  
position = '0.0 0.0 10.82'  
orientation = '0 0 1'  
A = 3.93  
Dh = 1.0  
length = 2.72  
n_elems = 40  
f = 0.1  
Hw = 0.  
aw = 400 # = 4 / dh, heat transfer surface density  
Tw = 600 # wall temperature  
eos = two_phase_eos  
model_type = 32  
stabilization_type = 'NONE'  
[../]
```

```
[./SeparatorDryer]  
type = SeparatorDryer  
eos = two_phase_eos  
center = '0.0 0.0 14.48'  
inputs = 'pipe6(out)'  
outputs = 'pipe7(in) pipe8(in)'  
K = '1.0 1.0 5.0'  
volume = 19.30  
Area = 10.27  
initial_T = 517.0  
initial_void_fraction = 0.9  
scale_factors = '1.0E-3 1.0E-9 1.0E-0' # rho, rhoE, vel  
[../]
```

```
[./pipe7] # to steam dome  
type = Pipe  
position = '0.0 0.0 15.42'  
orientation = '0 0 1'  
A = 3.93
```

```

Dh = 1.0
length = 0.1
n_elems = 20
f = 0.1
Hw = 0.0
aw = 400.0
Tw = 600
eos = vapor_phase_eos
model_type = 3
[../]

[./Dome]
type = VolumeBranch
eos = vapor_phase_eos
center = '0.0 0.0 18.92'
inputs = 'pipe7(out)'
outputs = 'pipe9(in)'
K = '1.0 1.0'
volume = 178.19
Area = 26.19
scale_factors = '1.0E-3 1.0E-8 1.0E-0'
[../]

#---Main steam line

[./pipe9]
# main steam line coming out of dome
type = Pipe
position = '0.0 3 18.92'
orientation = '0 1 0'
A = 1.32
Dh = 1.0
length = 1.0
n_elems = 5
f = 0.1
Hw = 0.0
aw = 400.0
Tw = 600
eos = vapor_phase_eos
model_type = 3
[../]

[./SteamLineBranch]
type = VolumeBranch
eos = vapor_phase_eos
center = '0.0 4 18.92'
inputs = 'pipe9(out)'
outputs = 'pipe14(in) pipe_venting1(in)'
K = '0.0 0.0 0'
volume = 2.64
Area = 1.32
initial_T = 517.0
scale_factors = '1.0E-4 1.0E-8 1.0'
[../]

[./pipe14]
# main steam line to MIV
type = Pipe

```

```

position = '0.0 4 18.92'
orientation = '0 1 0'
A = 1.32
Dh = 1.0
length = 1.0
n_elems = 5
f = 0.0
Hw = 0.0
aw = 400.0
Tw = 600
eos = vapor_phase_eos
model_type = 3
[../]

[./MainIsolationValve]
type = Valve
eos = vapor_phase_eos
center = '0.0 5.0 18.92'
inputs = 'pipe14(out)'
outputs = 'pipe_steam_turbine(in)'
K = '0.0 0.0'
volume = 1.32
Area = 1.32
initial_T = 517.0
initial_status = 1
trigger_time = 1 #1.0E5
response_time = 10 #1.1E5
scale_factors = '1.0E-4 1.0E-11' # rho, rhoE
[../]

[./pipe_steam_turbine]
# main steam line to TDV
type = Pipe
position = '0.0 5 18.92'
orientation = '0 1 0'
A = 1.32
Dh = 1.0
length = 1.0
n_elems = 5
f = 0.0
Hw = 0.0
aw = 400.0
Tw = 600
eos = vapor_phase_eos
model_type = 3
[../]

[./outlet1]
type = TimeDependentVolume
input = 'pipe_steam_turbine(out)'
p_bc = 7.0e6
T_bc = 517
eos = vapor_phase_eos
weak_bc = false
[../]

# steam venting line

```

```

[./pipe_venting1]
type = Pipe
model_type = 3
#stabilization_type = 'NONE'
eos = vapor_phase_eos
# geometry
position = '0 4 18.92'
orientation = '0 0 -1'
A = 1.2566e-1
Dh = 0.4
f = 0.1
Hw = 0.0 # not setting Hw means that Hw is calculated by models, need set 0 for no heat transfer
length = 5
n_elems = 10

initial_P = 7e6
initial_V = 0.
initial_T = 517.
[../]

```

```

[./branch_venting1]
type = VolumeBranch
eos = vapor_phase_eos
center = '0.0 4 13.92'
inputs = 'pipe_venting1(out)'
outputs = 'pipe_venting2(in)'
K = '100 100'
volume = 2.5132e-1
Area = 1.2566e-1
initial_T = 517.0
scale_factors = '1.0E-4 1.0E-8 1.0'
[../]

```

```

[./pipe_venting2]
type = Pipe
model_type = 3
#stabilization_type = 'NONE'
eos = vapor_phase_eos
# geometry
position = '0 4 13.92'
orientation = '0 1 0'
A = 1.2566e-1
Dh = 0.4
f = 0.1
Hw = 0.0 # not setting Hw means that Hw is calculated by models, need set 0 for no heat transfer
length = 4
n_elems = 10

initial_P = 7e6
initial_V = 0.
initial_T = 517.
[../]

```

```

[./branch_venting2]
type = VolumeBranch
eos = vapor_phase_eos
center = '0.0 8 13.92'
inputs = 'pipe_venting2(out)'

```

```
outputs = 'pipe_turbine_inlet(in)'  
K = '100 100'  
volume = 2.5132e-1  
Area = 1.2566e-1  
initial_T = 517.0  
scale_factors = '1.0E-4 1.0E-8 1.0'  
[../]
```

```
[./pipe_turbine_inlet]  
type = Pipe  
model_type = 3  
#stabilization_type = 'NONE'  
eos = vapor_phase_eos  
# geometry  
position = '0 8 13.92'  
orientation = '0 0 -1'  
A = 1.2566e-1  
Dh = 0.4  
f = 0.1  
Hw = 0.0 # not setting Hw means that Hw is calculated by models, need set 0 for no heat transfer  
length = 16.92  
n_elems = 10
```

```
initial_P = 7e6  
initial_V = 0.  
initial_T = 517.  
[../]
```

```
[./turbine]  
type = Turbine  
eos = vapor_phase_eos  
inputs = 'pipe_turbine_inlet(out)'  
outputs = 'pipe_turbine_outlet(in)'  
Turbine_efficiency = 0.6 #0.9  
max_mass_flow_rate = 2e-1  
relative_mass_flow_rate_design = 0.8  
pressure_ratio_design = 3.  
T0_design = 517  
p0_design = 7e6  
is_shutdown = 'false'  
scale_factors = '1e-1 1e-1 1e-5 1e-7' # for inlet pressure, outlet pressure, outlet density, and shaft work  
Initial_p = 7e6  
Initial_T = 517.  
[../]
```

```
[./pipe_turbine_outlet]  
type = Pipe  
model_type = 3  
#stabilization_type = 'SUPG'  
eos = vapor_phase_eos  
# geometry  
position = '0 9 -3'  
orientation = '0 0 -1'  
A = 1.2566e-1  
Dh = 0.4  
f = 0.1  
Hw = 0.0  
length = 6.5
```

```

n_elems = 10
initial_P = 1.5e5
initial_V = 1e-2
initial_T = 400
[../]

# -----
# water loop to simulate water drawing back to core
# -----

[./pipe_RCIC_pump_inlet]
type = Pipe
model_type = 3
stabilization_type = 'SUPG'
eos = liquid_phase_eos
# geometry
position = '0 6 -11'
orientation = '0 0 1'
Dh = 0.2
A = 3.141593e-2

f = 0.001
Hw = 0.0 # not setting Hw means that Hw is calculated by models, need set 0 for no heat transfer
length = 8
n_elems = 20

initial_P = 1e5
initial_V = 0
initial_T = 300
[../]

[./RCIC_pump]
type = IdealPump # IdealPump is good to simulate closed valve for incompressible fluid
eos = liquid_phase_eos
inputs = 'pipe_RCIC_pump_inlet(out)'
outputs = 'pipe_RCIC_pump_outlet(in)'
mass_flow_rate = 2e-1 #0 # this number should be equal or smaller than the max_mass_flow_rate for turbine

Initial_pressure = 1.0e5
[../]

[./pipe_RCIC_pump_outlet]
type = Pipe
model_type = 3
stabilization_type = 'SUPG'
eos = liquid_phase_eos
# geometry
position = '0 5 -3'
orientation = '0 -1 0'
Dh = 0.2
A = 3.141593e-2

f = 1e-3
Hw = 0.0 # not setting Hw means that Hw is calculated by models, need set 0 for no heat transfer
length = 1
n_elems = 5

initial_P = 7e6

```

```

initial_V = 0
initial_T = 517
[../]

[./branch_RCIC_water_line]
type = VolumeBranch
eos = liquid_phase_eos
center = '0 4 -2'
inputs = 'pipe_RCIC_pump_outlet(out)'
outputs = 'pipe_RCIC_to_feedwater_line(in)'
K = '0 0'
volume = 0.007853982
Area = 3.141593e-2
initial_T = 517.0
scale_factors = '1.0E-4 1.0E-8 1.0'
[../]

[./pipe_RCIC_to_feedwater_line]
type = Pipe
model_type = 3
stabilization_type = 'SUPG'
eos = liquid_phase_eos
# geometry
position = '0 4 -3'
orientation = '0 0 1'
Dh = 0.2
A = 3.141593e-2

f = 1e-4 #0.01
Hw = 0.0 # not setting Hw means that Hw is calculated by models, need set 0 for no heat transfer
length = 15.52
n_elems = 30

initial_P = 7e6
initial_V = 0
initial_T = 517
[../]

# -----
# gas vent loop to simulate venting to dry well
# -----

[./pipe_to_dry_well]
type = Pipe
model_type = 3
stabilization_type = 'NONE'
eos = eos_nc
# geometry
position = '0 11 -4'
orientation = '0 1 0'
Dh = 0.2
A = 0.031415927

f = 0.01 #0.2
Hw = 0.0 # not setting Hw means that Hw is calculated by models, need set 0 for no heat transfer
length = 0.2
n_elems = 50

```

```

initial_P = 1e5
initial_V = 0
initial_T = 300
[../]

[./VacuumBreaker]
type = Valve
eos = eos_nc
center = '0 11.2 -4'
inputs = 'pipe_to_dry_well(out)'
outputs = 'pipe_to_dry_well2(in)'
K = '0.0 0.0'
Area = 0.031415927
volume = 3.142e-3
Initial_pressure = 1.e5
initial_T = 300

initial_status = 0
trigger_time = 1.0E100
response_time = 1.1E100
scale_factors = '1.0E-4 1.0E-11' # rho, rhoE
[../]

[./pipe_to_dry_well2]
type = Pipe
model_type = 3
stabilization_type = 'NONE'
eos = eos_nc
# geometry
position = '0 11.3 -4'
orientation = '0 1 0'
Dh = 0.2
A = 0.031415927

f = 0.01 #0.2
Hw = 0.0 # not setting Hw means that Hw is calculated by models, need set 0 for no heat transfer
length = 0.2
n_elems = 50

initial_P = 1e5
initial_V = 0
initial_T = 300
[../]

[./Dry_well]
type = TimeDependentVolume
input = 'pipe_to_dry_well2(out)'
p_bc = 1.e5
T_bc = 300
eos = eos_nc
[../]

# -----
# wet well
# -----

```



```

[./wet_well]
type = WetWell
inputs = 'pipe_turbine_outlet(out)'
outputs = 'pipe_RCIC_pump_inlet(in) pipe_to_dry_well(in)'

eos_water = liquid_phase_eos
eos_vapor = vapor_phase_eos
eos_nc_gas = eos_nc

z_in = 2.5
z_out = 1
Ac = 892.5 FIXME
Lt = 8
alpha_s = 1e3
cooling_rate = 0.0
K_i = 100
K_ir = 1e6
K_o = 0.1
K_or = 1.0
K_v = 0.5
K_vr = 1.0
Lw_initial = 4
p_gas_initial = 1.e5
T_initial = 300.0

scale_factors = '1e-5 1e-10 1e-7 1e-13 1e-6' # for mg, me_g, mw, me_w, Lw
[../]

```

separated water return line

```

[./pipe8] # discharge water line from SeparatorDryer
type = Pipe
position = '0.0 2.0 14.48'
orientation = '0 1 0'
A = 3.93
Dh = 1.0
length = 0.5
n_elems = 5
f = 0.1
Hw = 0.0
aw = 400.0
Tw = 600
eos = liquid_phase_eos
model_type = 3
[../]

```

```

[./DownComer]
type = DownComer
eos = liquid_phase_eos
dome_eos = vapor_phase_eos
center = '0.0 2.75 9.81' #'0.0 4.0 9.81'
inputs = 'pipe8(out) pipe_feedwater3(out)'
outputs = 'pipe10(in)'
K = '1.0 10.0 1.0'
volume = 201.3

```

```
Area = 15
initial_level = 13.42
initial_T = 517.0
dome_component = 'Dome'
display_pps = 'true'
scale_factors = '1.0E-4 1.0E-10 1.0E-2' # mass, energy, and level
[../]
```

```
[./pipe10] # downcomer pipe
type = Pipe
#position = '0.0 5.0 10.51'
position = '0.0 2.75 2.10'
orientation = '0 0 -1'
A = 8.55
Dh = 1.0
#length = 6.42
length = 0.5
n_elems = 5
f = 0.1
Hw = 0.0
aw = 400.0
Tw = 600
eos = liquid_phase_eos
model_type = 3
stabilization_type = 'SUPG'
[../]
```

```
[./Pump]
#type = IdealPump
type = Pump
eos = liquid_phase_eos
inputs = 'pipe10(out)'
outputs = 'pipe11(in)'
Area = 3.0
Initial_pressure = 7.3e6
#mass_flow_rate = 12915.0
Head = 40
K_reverse = '10. 10.'
[../]
```

```
[./pipe11] # pipe to lower plenum
type = Pipe
position = '0.0 2.75 1.60'
orientation = '0 0 -1'
A = 8.55
Dh = 1.0
length = 0.5
n_elems = 5
f = 0.1
Hw = 0.0
aw = 400.0
Tw = 600.0
eos = liquid_phase_eos
model_type = 3
stabilization_type = 'SUPG'
[../]
```

```
# feed water line
```

```

[./inlet]
type = TimeDependentVolume
input = 'pipe_feedwater1(in)'
p_bc = 7.1e6
T_bc = 508.
void_fraction_bc = -0.01
eos = liquid_phase_eos
[../]

[./pipe_feedwater1]
#feedwater line from TDV
type = Pipe
position = '0.0 6.0 12.52'
orientation = '0 -1 0'
A = 1.32
Dh = 1.0
length = 1.0
n_elems = 5
f = 0.01
Hw = 0.
aw = 400.0
Tw = 600.0
eos = liquid_phase_eos
model_type = 3
stabilization_type = 'SUPG'
[../]

[./FeedWaterValve]
type = Valve
eos = liquid_phase_eos
center = '0.0 5.0 12.52'
inputs = 'pipe_feedwater1(out)'
outputs = 'pipe_feedwater2(in)'
K = '0.0 0.0'
volume = 1.32
Area = 1.32
initial_T = 517.0
initial_status = 1
trigger_time = 1 #1.0E5
response_time = 1 #1.1E5
scale_factors = '1.0E-4 1.0E-11' # rho, rhoE
[../]

[./pipe_feedwater2]
#feedwater line from feed water valve
type = Pipe
position = '0.0 5.0 12.52'
orientation = '0 -1 0'
A = 1.32
Dh = 1.0
length = 1.0
n_elems = 5
f = 0.01
Hw = 0.
aw = 400.0
Tw = 600.0
eos = liquid_phase_eos

```

```

model_type = 3
stabilization_type = 'SUPG'
#stabilization_type = 'LAPIDUS'
[../]

[./branch_feedwater_line]
type = VolumeBranch
eos = liquid_phase_eos
center = '0.0 4.0 12.52'
inputs = 'pipe_feedwater2(out)'
outputs = 'pipe_feedwater3(in) pipe_RCIC_to_feedwater_line(out)'
K = '0 0 0'
volume = 1.32
Area = 1.32
initial_T = 517.0
scale_factors = '1.0E-4 1.0E-8 1.0'
[../]

[./pipe_feedwater3]
#feedwater line to downcomer
type = Pipe
position = '0.0 4.0 12.52'
orientation = '0 -1 0'
A = 1.32
Dh = 1.0
length = 1.0
n_elems = 5
f = 0.01
#f = 0
Hw = 0.
aw = 400.0
Tw = 600.0
eos = liquid_phase_eos
model_type = 3
stabilization_type = 'SUPG'
[../]

[]

[Preconditioning]
# active = 'SMP_Newton'
active = 'SMP_PJFNK'
# active = 'FDP_PJFNK'
#active = 'FDP_Newton'

[./SMP_Newton]
type = SMP
full = true
petsc_options = '-snes'
[../]

[./SMP_PJFNK]
type = SMP
full = true
petsc_options = '-snes_mf_operator'

petsc_options_iname = '-mat_fd_type -mat_mffd_type'
petsc_options_value = 'ds ds'

```

```

[../]

[./FDP_PJFNK]
type = FDP
full = true
petsc_options = '-snes_mf_operator'
petsc_options_iname = '-mat_fd_type -mat_mffd_type'
petsc_options_value = 'ds ds'
[../]

[./FDP_Newton]
type = FDP
full = true
petsc_options = '-snes'
petsc_options_iname = '-mat_fd_coloring_err'
petsc_options_value = '1.e-10'
[../]
[] # End preconditioning block

[Executioner]

type = RavenExecutioner

#predictor_scale = 0.5

dt = 1e-2
dtmin = 1.e-8

[./TimeStepper]
type = FunctionDT
# steady state time step control
#time_t = '0 0.01 0.1 0.5 20 50 100 1e5'
#time_dt = '1e-3 2.e-3 2.e-3 1.e-2 1.1e-2 1.5e-2 2e-2 2e-1'
#time_dt = '5e-3 5.e-3 5.e-3 2.e-2 4.e-2 1e-1 2e-1 5e-1'
# transient time step control
time_t = '0 10 15 20 1e5'
time_dt = '1e-1 1e-1 1e-2 1e-1 1e-1'
#time_t = '0 10 15 20 100 2420 2430 2730 2740 5140 5150 5450 5460 1e5'
#time_dt = '1e-1 1e-1 1e-2 1e-1 2e-1 2e-1 1e-1 1e-1 2e-1 2e-1 1e-1 1e-1 2e-1 2e-1'
[../]

petsc_options_iname = '-ksp_gmres_restart -pc_type'
petsc_options_value = '30 lu'

nl_rel_tol = 1e-8
nl_abs_tol = 1e-4
nl_max_its = 6

l_tol = 1e-4 # Relative linear tolerance for each Krylov solve
l_max_its = 30 # Number of linear iterations for each Krylov solve

start_time = 0
end_time = 2.88e4 # 8 hrs
num_steps = 500000000 # The number of timesteps in a transient run
restart_file_base = SBO_8_6_small_steady_out_restart_1308

[./Quadrature]

```

```

type = TRAP
# Specify the order as FIRST, otherwise you will get warnings in DEBUG mode...
order = FIRST
[../]
[] # close Executioner section

[Output]
# Turn on performance logging
perf_log = true
interval = 10
#postprocessor_screen = false
output_initial = true
output_displaced = true
postprocessor_csv = true
num_restart_files = 1
[]

[Debug]
# show_var_residual_norms = true
[]

[Controlled]
control_logic_input = SBO_control_logic_40
[./turbine_max_mass_flow_rate]
component_name = turbine
property_name = max_mass_flow_rate
data_type = double
[../]
[./RCIC_pump_flow_rate]
component_name = RCIC_pump
property_name = mass_flow_rate
data_type = double
[../]
[./HeadPump]
print_csv = true
data_type = double
property_name = Head
component_name = Pump
[../]

[]

[RavenTools]
[./PumpCoastDown]
type = pumpCoastdownExponential
coefficient = 1 #2
initial_flow_rate = 40
[../]
[]

[Monitored]
[./ch1cladtemperature]
operator = NodalMaxValue #ElementAverageValue
path = CLAD:TEMPERATURE
data_type = double
component_name = ch1
[../]

```

```
[]
```

RAVEN Control file:

```
import sys
import math
import distribution1D
import raventools
distcont = distribution1D.DistributionContainer.Instance()
# initialize distribution container
toolcont = raventools.RavenToolsContainer.Instance()

#This works with
#../RAVEN-devel -s TypPWR_Mult_CoreChannels_test.i
#If run from a different directory PYTHONPATH needs to be set to
# allow this to be found.
def initial_function(monitored, controlled, auxiliary):
    return

def control_function(monitored, controlled,auxiliary):
    controlled.HeadPump = toolcont.compute('PumpCoastDown',monitored.time)

# first period of turning on RCIC system for 30 min
if (monitored.time > 10) and (monitored.time <= 20):
    controlled.turbine_max_mass_flow_rate = 0.2 + (40 - 0.2) * (monitored.time - 10) / 10
    controlled.RCIC_pump_flow_rate = (0.2 + (40 - 0.2) * (monitored.time - 10) / 10)
if (monitored.time > 20) and (monitored.time <= 1820):
    controlled.turbine_max_mass_flow_rate = 40
    controlled.RCIC_pump_flow_rate = 40
if (monitored.time > 1820) and (monitored.time <= 1830):
    controlled.turbine_max_mass_flow_rate = 40 + (0.2 - 40) * (monitored.time - 1820) / 10
    controlled.RCIC_pump_flow_rate = (40 + (0.2 - 40) * (monitored.time - 1820) / 10)

# first period of turning off RCIC system for 15 min
if (monitored.time > 1830) and (monitored.time <= 2730):
    controlled.turbine_max_mass_flow_rate = 0.2
    controlled.RCIC_pump_flow_rate = 0.2

# 2nd period of turning on RCIC system for 30 min
if (monitored.time > 2730) and (monitored.time <= 2740):
    controlled.turbine_max_mass_flow_rate = 0.2 + (40 - 0.2) * (monitored.time - 2730) / 10
    controlled.RCIC_pump_flow_rate = (0.2 + (40 - 0.2) * (monitored.time - 2730) / 10)
if (monitored.time > 2740) and (monitored.time <= 4540):
    controlled.turbine_max_mass_flow_rate = 40
    controlled.RCIC_pump_flow_rate = 40
if (monitored.time > 4540) and (monitored.time <= 4550):
    controlled.turbine_max_mass_flow_rate = 40 + (0.2 - 40) * (monitored.time - 4540) / 10
    controlled.RCIC_pump_flow_rate = (40 + (0.2 - 40) * (monitored.time - 4540) / 10)

# 2nd period of turning off RCIC system for 15 min
if (monitored.time > 4550) and (monitored.time <= 5450):
    controlled.turbine_max_mass_flow_rate = 0.2
    controlled.RCIC_pump_flow_rate = 0.2

# 3rd period of turning on RCIC system for 30 min
if (monitored.time > 5450) and (monitored.time <= 5460):
    controlled.turbine_max_mass_flow_rate = 0.2 + (20 - 0.2) * (monitored.time - 5450) / 10
```

```
    controlled.RCIC_pump_flow_rate = (0.2 + (20 - 0.2) * (monitored.time - 5450) / 10)
if (monitored.time > 5460) and (monitored.time <= 7260):
    controlled.turbine_max_mass_flow_rate = 20
    controlled.RCIC_pump_flow_rate = 20
if (monitored.time > 7260) and (monitored.time <= 7270):
    controlled.turbine_max_mass_flow_rate = 20
    controlled.RCIC_pump_flow_rate = (20 + (0.2 - 20) * (monitored.time - 7260) / 10)

# just release pressure through turbine
if (monitored.time > 7270):
    controlled.turbine_max_mass_flow_rate = 20
    controlled.RCIC_pump_flow_rate = 0.2

return
```