

M2LW-15OR0404024
PNNL-24649



Light Water Reactor Sustainability Program

State-of-the-Art Assessment of NDE Techniques for Aging Cable Management in Nuclear Power Plants FY2015



September 2015

U.S. Department of Energy

Office of Nuclear Energy

DISCLAIMER

This information was prepared as an account of work sponsored by an agency of the U.S. Government. Neither the U.S. Government nor any agency thereof, nor any of their employees, makes any warranty, expressed or implied, or assumes any legal liability or responsibility for the accuracy, completeness, or usefulness, of any information, apparatus, product, or process disclosed, or represents that its use would not infringe privately owned rights. References herein to any specific commercial product, process, or service by trade name, trade mark, manufacturer, or otherwise, does not necessarily constitute or imply its endorsement, recommendation, or favoring by the U.S. Government or any agency thereof. The views and opinions of authors expressed herein do not necessarily state or reflect those of the U.S. Government or any agency thereof.

M2LW-15OR0404024
PNNL-24649

State-of-the-Art Assessment of NDE Techniques for Aging Cable Management in Nuclear Power Plants FY2015

SW Glass, LS Fifield, G Dib, JR Tedeschi, AM Jones, TS Hartman

September 2015

**Prepared for the
U.S. Department of Energy
Office of Nuclear Energy**

Light Water Reactor Sustainability Program

**State-of-the-Art Assessment of NDE Techniques for
Aging Cable Management in Nuclear Power Plants
FY2015**

**M2LW-15OR0404024
PNNL-24649**

SW Glass, LS Fifield, G Dib, JR Tedeschi, AM Jones, TS Hartman

Approved by:



Steve N. Schlahta
Director, Nuclear Science Project Management Office

September 8, 2015

Date

SUMMARY

This milestone report presents an update on the state-of-the-art review and research being conducted to identify key indicators of cable aging at nuclear power plants (NPPs), and devise in-situ measurement techniques that are sensitive to these key indicators. The motivation for this study stems from the need to address open questions related to nondestructive evaluation (NDE) of aging cables for degradation detection and estimation of condition-based remaining service life. These questions arise within the context of a second round of license extension for NPPs that would extend the operating license from 60 to 80 years. Within the introduction, a review of recent published U.S. and international research and guidance for cable aging management programs including NDE technologies is provided. As with any “state-of-the-art” report, the observations are deemed accurate as of the publication date but cannot anticipate evolution of the technology. Moreover, readers are advised that research and development of cable NDE technology is an ongoing issue of global concern.

Cable safety factors offer significant margin for normal operation and consequently most cables can be expected to perform satisfactorily under normal loads. Cables are inherently tested as part of the regular system tests that are periodically performed on nuclear plant systems and active components. As emphasized in Regulatory Guide 1.128, the cable aging management program focuses on the ability of a cable to withstand extreme stresses such as in a design-basis event (DBE) that may not be addressed with normal system tests. Degradation of the electrical insulation and other cable components are key issues that are likely to affect the ability of the currently installed cables to operate safely and reliably under a DBE for another 20 to 40 years beyond the initial qualified operating life. With more than 1000 km of power, control, instrumentation, and other cables typically found in a NPP, it would be a daunting undertaking to inspect all of the cables. Practical guidelines, however, have been developed and are evolving that offer a manageable approach to sampling and screening cables based on accessibility, risk, history, and other factors. Moreover, the range of cables and conditions plus today’s state of the art does not support a single test to assure the cable’s function. Rather, a range of testing tools must be applied to manage the cable aging concerns and assure that degraded cables are repaired or replaced prior to the end of their safe operating life. Cable aging management program recommendations include a database of cables selected for test and trending including the required appropriate cable test based on accessibility, risk, and environment. Such tests include bulk electrical characteristic measurements that can be made from the cable ends and, in some cases, locate the weak portion of the cable as well as local tests to confirm insulation condition and provide guidance to predict remaining available safe life.

The Pacific Northwest National Laboratory has developed an accelerated cable aging capability that allows both thermal and radiation aging of small segments of intact cable (up to a few feet) as well as cut-out insulation samples suitable for laboratory testing. These aged cables and samples can be tested by a variety of laboratory and in-situ capable NDE techniques including some where a significant length of cable is batch tested during brief interruptions of the thermal and/or radiation accelerated aging environmental exposure, or on-line tested even with an electrical load.

Currently, the gold standard for determining cable insulation degradation (through a measurement of cable elasticity) is the elongation-at-break (EAB) measurement. This is an ex-situ measurement and requires taking a sample of cable insulation for laboratory investigation. EAB applied to cable insulation provides a measure of mechanical toughness that is most closely associated with damage mechanisms of concern in a DBE. Practical NDE tests however must be possible to apply in-situ inside the NPPs so the focus of qualification of the NDE tests is correlation with EAB. Test approaches are divided into two categories—bulk electrical tests, and local tests. Bulk electrical tests include time domain reflectometry, $\tan \delta$, frequency-domain reflectometry (FDR), and other tests that can be applied in-situ from cable termination locations within the NPPs. Many of these tests provide information regarding the location of the weakest section of cable as well as an indication of the overall cable condition. Local tests such as visual observation, Fourier transform infrared spectroscopy, indenter, dynamic mechanical analysis, and capacitance probes provide indications of the jacket and insulation condition at the tested location. This can serve as a stand-alone evaluation and assessment of a cable condition if the tested location is clearly the most susceptible to damage and/or can complement the bulk electrical tests to justify leaving a cable in service or targeting a cable for repair or replacement. More detailed discussions on each NDE technique is presented within the report.

Gaps in our understanding of capabilities and limitations of these various testing approaches are being systematically filled as this research continues. Going forward, the program expects to better quantify capabilities of $\tan \delta$ for lower voltage cables, to look at alternate implementations of FDR, and more precisely address capabilities and limitations of local mechanical and capacitance tests.

CONTENTS

SUMMARY	vii
ACRONYMS AND ABBREVIATIONS	ix
1. OBJECTIVES OF THIS REPORT	1.1
2. REPORT ORGANIZATION.....	2.1
3. INTRODUCTION.....	3.1
3.1 Background	3.1
3.2 Cable Design, Material, Grouping and Categorization.....	3.3
3.3 Recent Cable Test Aging Management Studies and Guidance.....	3.5
3.4 Project Objectives	3.6
4. THERMAL AND RADIATION ACCELERATED AGING, PLUS ELECTRICAL TEST BED	4.1
5. BULK ELECTRICAL MEASUREMENTS	5.1
5.1 Time Domain Reflectometry.....	5.2
5.2 Tan δ Measurements.....	5.2
5.3 Frequency-Domain Reflectometry	5.4
5.3.1 Simulated Cable Defects.....	5.5
5.3.2 Mechanical Cable Defects	5.6
5.4 Partial Discharge	5.10
6. LOCAL MEASUREMENTS	6.1
6.1 Fourier Transform Infrared Spectroscopy.....	6.1
6.2 Visual Walk-Downs	6.2
6.3 Elongation at Break.....	6.2
6.4 Indenter	6.3
6.5 Dynamic Mechanical Analysis	6.4
6.6 Ultrasonic Measurements of Sound Speed and Attenuation.....	6.8
6.7 Interdigital Capacitor Technique.....	6.10
6.8 Embedded Micro Sensors	6.11
7. SUMMARY	7.1
8. PATH FORWARD.....	8.1
9. REFERENCES	9.1

FIGURES

3.1	Overview of Research Tasks for Cable Aging Detection and Remaining Life Assessment	3.3
3.2	Cable Configurations: Top – Unshielded Single Conductor; Middle – Shielded Single Conductor; Bottom – Unshielded Multi-Conductor; courtesy of Okonite.....	3.4
4.1	Accelerated Cable Aging Oven with Rack of Test Polymers and Pass-Through Cables	4.1
4.2	⁶⁰ Co Gamma Radiation Chamber Capable of up to 6K Curies for Cable Aging Studies	4.2
4.3	Graphic Representation of Measurement Circuit.....	4.2
4.4	Photograph Showing the Cable Aging Test Bed.	4.3
5.1	Typical TDR Graph Showing Cable Ends Plus Three Reflections of Terminations, Splices, or Field Penetrations in Between.....	5.2
5.2	Phasor Relationship between the Real and Imaginary Components of Permittivity	5.3
5.3	Tan Delta Model 34K	5.4
5.4	Example Tan Delta Test Result of New and Aged Cable	5.4
5.5	Simulated FDR Responses without White Noise for RG-58 Coaxial Cable	5.5
5.6	Simulated FDR Responses with 0.5% White Noise Level for RG-58 Coaxial Cable	5.6
5.7	Simulated FDR Responses with 0.5% White Noise for Twisted Pair Cable with 1 inch Defect Located at 100 ft.....	5.6
5.8	General Construction of Okonite-FMR Okoseal Type Triplex Cable	5.7
5.9	FDR Response Spectra for: (a) Unshielded Triplex Cable Before and After Insulation Removal from One Conductor at 300 ft.; (b) Shielded Cable with Shield Insulation Abraded at 25 m.....	5.7
5.10	Measured FDR Responses for 350 ft. Length of Brand New Okonite-FMR Cable	5.8
5.11	Okonite-FMR Cable with 2.5-inch Section of Jacket Removed at 300 ft.	5.8
5.12	FDR Measurements of Black-Blue Conductor Pair in 350 ft. Okonite-FMR Cable with 2.5-inch Jacket Section Removed at 300 ft.....	5.9
5.13	Okonite-FMR Cable with 2.5-inch Section of Jacket and Red Wire Insulation Removed at 300 ft.	5.9
5.14	FDR of Black-Red Conductor Pair in 350 ft. Okonite-FMR Cable with 2.5-inch Section of Jacket and Red Wire Insulation Removed at 300 ft.....	5.10
6.1	FTIR Spectra of Aged and Un-aged EPR	6.2
6.2	(a) Elongation at Break Dog Bone Sample; (b) EAB for Aged EPR Samples	6.3
6.3	Indenter Concept (a) and Actual Tool (b).....	6.4
6.4	Plot of Indenter Modulus vs. Time at 140°C in Air for Shielded EPR Cable with Jacket.....	6.4
6.5	(a) Image of the DMA Instrument with Compression Tip for Shear Modulus and an Illustration of a Simple Schematic and Input/Output Waveforms for Analysis; (b) Photograph of Tensile DMA Instrument Setup with Cable Insulation Specimen.....	6.6
6.6	DMA Data Schematic Illustrating the Available Information Determined by DMA	6.7
6.7	DMA Data for Unaged Okoguard Jumper Cable.....	6.7

6.8	Storage Modulus of 140°C Thermally Aged EPR Okoguard Jumper Cable	6.8
6.9	UT Velocity Measurement Setup for EPR Cable	6.9
6.10	Waveforms at Each Scan Location	6.9
6.11	EPR Ultrasound Velocity as a Function of Accelerated Thermal at 140°C Aging Shows Poor Correlation.....	6.10
6.12	Experimental Configuration for Capacitance Measurements Showing Impedance Analyzer and Clamshell Fixture Used to Wrap the Sensor onto the Outer Surface of the Cable	6.11
6.13	Electrostatic Field Simulation Model of Interdigital Capacitive Sensor and Electric Flux Distribution Inside Cable Insulation	6.11

TABLES

3.1	A Sort of Insulation Material for U.S. NPPs.....	3.4
3.2	Categories of Cable Grouping	3.5
3.3	NUREG/CR-7000 Nine-Step Program for Aging Cable Management	3.7
5.1	Available Common Techniques for Bulk Electrical Cable Inspection	5.1
5.2	FDR Test and Simulation Conditions and Observations	5.7
6.1	Available Common Techniques for Local Cable Inspection	6.1

ACRONYMS AND ABBREVIATIONS

CM	condition monitoring
DBE	design-basis event
DMA	dynamic mechanical analysis
DOE	U.S. Department of Energy
EAB	elongation at break
EPR	ethylene propylene rubber
EPRI	Electric Power Research Institute
FDR	frequency-domain reflectometry
FTIR	Fourier transform infrared (spectroscopy)
IAEA	International Atomic Energy Agency
LWRS	Light Water Reactor Sustainability Program
NDE	nondestructive evaluation
NPP	nuclear power plant
NRC	U.S. Nuclear Regulatory Commission
PD	partial discharge
PNNL	Pacific Northwest National Laboratory
PVC	polyvinyl chloride
TDR	time domain reflectometry
U _o	1 U _o is normal line voltage. 2 U _o is twice normal line voltage
VNA	vector network analyzer
XLPE	cross-linked polyethylene

State-of-the-Art Assessment of NDE Techniques for Aging Cable Management in Nuclear Power Plants FY2015

1. OBJECTIVES OF THIS REPORT

This Pacific Northwest National Laboratory (PNNL) milestone report describes progress to date on investigating nondestructive test methods that provide key indicators of cable aging and damage. The work includes a review of relevant recent literature as well as hands-on experimental verification of inspection capabilities. PNNL has developed capabilities for thermal, radiation, and combined thermal and radiation aging of small cable sample sets. In some cases, the aging is coupled with test beds that support condition monitoring as the samples are aged. Details of the aging facility and general laboratory test capabilities have been reported elsewhere (Ramuhalli et al. 2015) so this information is only noted as it relates to characterizing the inspection methods. Moreover, inspection methods are focused on approaches that can be deployed in-situ to nuclear power plants (NPPs). Some of the methods are currently laboratory-based, but it is expected that they could be customized for in-situ measurements in an NPP field environment if the laboratory results created a compelling case for such an evolution of the method.

This report is submitted in fulfillment of deliverable M2LW-15OR0404024 – COMPLETE REPORT DOCUMENTING ASSESSMENT OF STATE OF THE ART NONDESTRUCTIVE EXAMINATION TECHNIQUES FOR CABLE AGING (PERFORMANCE MILESTONE).

2. REPORT ORGANIZATION

This document is organized as follows. The Executive Summary includes a brief description of the material covered in the report focusing on significant observations and conclusions. Section 1 describes the report and research objectives; Section 2 explains the report organization. Section 3 provides an introduction and background to the topic including a review of recent relevant literature. Section 4 summarizes PNNL's facilities for accelerated cable aging coupled with laboratory and in-situ condition monitoring and fundamental material characteristic measurement capabilities. Section 5 addresses bulk electrical test methods. Section 6 addresses local test approaches. Section 7 summarizes conclusions for this period's work. Section 8 addresses the planned path forward. And finally, Section 9 chronicles the references used in the report.

3. INTRODUCTION

The aging of insulation and jacketing material in electrical and instrumentation cables is considered to be one of the factors that may limit the ability of light water reactors to continue operations beyond their licensed period (up to 60 and 80 years, depending on the specific plant). The most important requirement for cables (electrical or instrumentation) in NPPs is the ability to withstand a design-basis accident. Aging and subsequent degradation of insulation will impair the ability of cables to perform their function under all environmental conditions. Methods to nondestructively assess the level of aging and degradation in cable insulation and jacketing materials are therefore needed. In addition to providing an estimate of the level of aging and degradation, such condition assessment or condition monitoring (CM) methods for cable insulation can also provide critical inputs into proposed condition-based qualification approaches, assess corresponding remaining useful qualified life of the cable, and ensure that the cables do not exceed a qualified level of degradation.

Acceptance criteria that define the threshold for degradation below which cables may continue to be used are a challenge, because it is impractical to subject each cable system to loss-of-coolant accident or seismic simulation events following 40+ years of service. EPRI Technical Report 1008211, “Initial Acceptance Criteria Concepts and Data for Assessing Longevity of Low-Voltage Cable Insulations and Jackets” (EPRI 2005) develops a basis for acceptance criteria and evaluates the aging profiles for many commonly used cable jackets and polymers. The report describes 50 percent elongation at break (EAB) as a conservative practical end-of-life threshold for cables that may be stressed during maintenance or subjected to loss-of-coolant accident exposure. The report also discusses the basis for cautious continued use of cables beyond the 50-percent EAB threshold. EAB, however, is a destructive ex-situ test so the challenge is to develop nondestructive evaluation (NDE) methods that can reasonably be correlated with EAB.

3.1 Background

In July 2012, a workshop (Simmons et al. 2012) was held to lay the groundwork for a research and development roadmap to address aging cable management in NPPs, including methods for nondestructively measuring the condition of aging cables. This workshop brought together subject matter experts from the U.S. Nuclear Regulatory Commission (NRC), U.S. Department of Energy (DOE) national laboratories, the Electric Power Research Institute (EPRI), universities, and cable manufacturers and inspectors.

The workshop focused on identifying key research needs in the NDE of aging cable insulation in NPPs and the associated technical gaps. Identifying measurable characteristics due to changes in chemical structure of insulating materials that would be a precursor to eventual failure of an aging cable, and state-of-the-art in NDE methods that could be applied to estimate the remaining life of the cable, were determined to be key to addressing the aging management challenge for nuclear cables. The changes in chemical structure are most likely to be caused by the cable environment (thermal, radiation, moisture, and chemical). Mechanical integrity may be compromised by environmental factors but usually occurs as a direct result of mechanical loads (both static and dynamic). Cables could be replaced and thereby benefit from an extended period where no special testing and condition-based monitoring would be required, but wholesale cable replacement is extremely expensive compared to a CM inspection program. Further, the idea that cables can be replaced and not be subject to CM is likely not acceptable with respect to anticipated aging management program changes for second license renewal. Such a program must be minimally disruptive of plant operation, essentially mandating that the cables be tested in-situ. The development of new NDE methods or evolution of new measurement techniques using existing NDE methods that target these types of changes is of significant interest. Further, the ability to perform a nondestructive test to determine chemical, physical, mechanical, and electrical properties of the cable jackets and insulation without significant disturbance of the cables and connectors as they lay in-situ is essential.

There have been many programs and years of research to address the problems of aging nuclear cables (for instance, Yamamoto and Minakawa 2009; Villaran and Lofaro 2010; IAEA 2012) with no single NDE method identified that can satisfy all of the requirements needed to assess life expectancy. Currently, the gold standard for determining cable insulation degradation (through a measurement of cable elasticity) is the EAB measurement. This is an ex-situ measurement and requires taking a sample of cable insulation for laboratory investigation.

NDE test criteria include the following considerations:

- The test should be possible to perform in-situ with limited interruption of plant operation. Typically such tests are performed during plant outages so systems need not be energized but the cable must not be required to be removed. If the cable were removed, it would make more sense to replace the cable with a new cable and thereby minimize inspection demands.
- Although it is acceptable to de-terminate the ends of cables for test and then re-terminate the cable ends because usually the termination points are reasonably accessible, it is preferable to perform the tests without de-terminating.
- Bulk electrical tests of the cable are important because frequently it is difficult to touch or see significant sections of the cable. If the bulk cable tests do not pass their acceptance criteria, additional measures must be employed to identify the weakest cable area for additional local tests and repair or replacement if required.
- Some bulk electrical tests use low voltages and are completely nondestructive. Others, however, apply higher voltages greater than line operation levels and can create a destructive arc-flash—particularly in marginalized or damaged cable systems. The risk of higher voltage tests must be balanced against improved performance and test sensitivity to degradation of interest.
- Local cable tests (indenter, visual tests, bending cable around minimum bend radius mandrills, capacitance, etc.) must be easily performed even in access-challenged locations because much of the cable within U.S. NPPs is difficult to access.
- An ideal NDE method has absolute acceptance criteria. Inspection sensitivity, however, can be increased and the influence of noise significantly reduced by using relative tests where current data are compared to baseline reference measurements.

The workshop identified three important areas that should be considered to assess overall cable aging:

- Determination of the key chemical, physical, and electrical indicators of cable aging
- Advance current and develop new NDE methods to enable in-situ cable condition assessment
- Develop models to assist in predicting remaining useful life of aging cables.

Figure 3.1 succinctly illustrates the importance of using NDE to predict remaining useful qualified life of aging cables and the individual properties that must be considered.

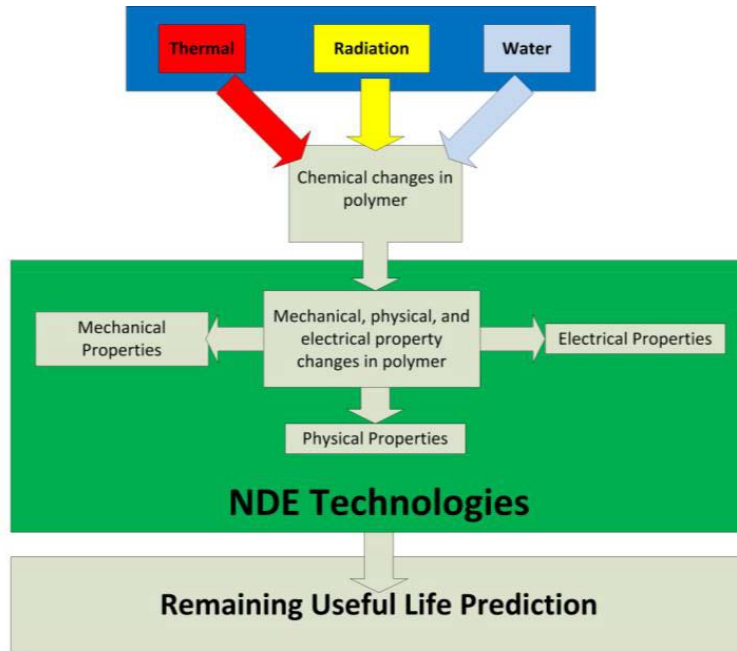

Figure 3.1. Overview of Research Tasks for Cable Aging Detection and Remaining Life Assessment

Subsequently (in late 2013 through early 2014), the research tasks listed in Figure 3.1 were integrated into a coordinated research plan jointly developed by DOE Office of Nuclear Energy (through the Light Water Reactor Sustainability Program [LWRS] program), the NRC, and industry (represented by EPRI). Several coordination meetings have taken place and the research activities under this integrated coordinated research plan have been shared and vetted among the lead research organizations and key stakeholders such as utilities, DOE, and NRC are also involved in the research plan vetting.

Within the context of this project, developments from other research activities within this coordinated plan are leveraged for specimens, identification of key indicators, and access to measurement techniques. At the same time, results from this project are shared with the other activities for subsequent use in determining measurement techniques, analysis methods, and input into cable qualification techniques.

3.2 Cable Design, Material, Grouping and Categorization

Nuclear power plant cable designs typically include a conductor and an insulating cover (Figure 3.2). They may include more than one insulated conductor within the bundle. Other components typically associated with the overall cable design include a semiconductor screen, a shield, binder tape, and a jacket.

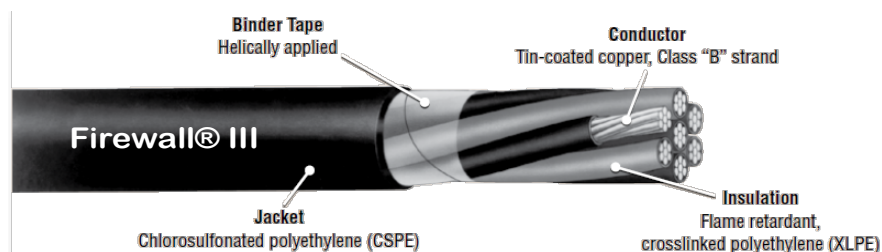
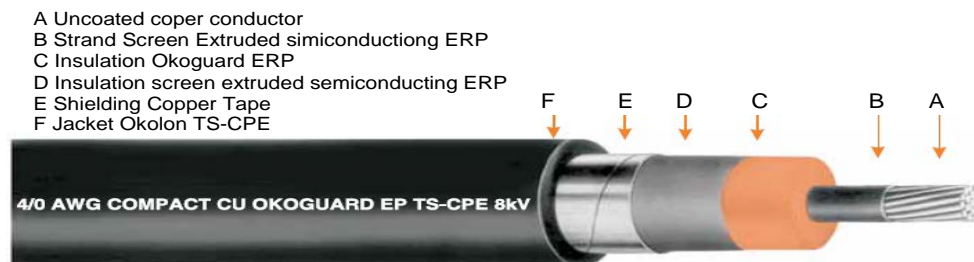

Figure 3.2. Cable Configurations: Top – Unshielded Single Conductor; Middle – Shielded Single Conductor; Bottom – Unshielded Multi-Conductor; courtesy of Okonite

The material for these cable components are chosen based on the environment and the application. Conductors are relatively insensitive to age and related damage. The jacket material may be a leading indicator of aging due to temperature or radiation, but the relatively thin jacket material (compared to the insulation) is not a principal contributor to the electrical and mechanical cable aging behavior. Rather insulation materials dominate the behavior of the cable systems because they provide the vast majority of the material. A survey performed by EPRI in the mid-1990s established a representative distribution of insulation materials within the U.S. nuclear fleet that was then analyzed by Oak Ridge National Laboratory and published (NRC 2013) (Table 3.1). Note that over 70 percent of the materials are cross-linked polyethylene (XLPE) or ethylene propylene rubber (EPR).

Table 3.1. A Sort of Insulation Material for U.S. NPPs (from NRC 2013; NUREG/CR-7153, Vol. 5)

Insulation Material	Database Entries	Percent of Total (%)	Insulation Material	Database Entries	Percent of Total (%)
XLPE	439	36	ETFE	39	3
EPR	434	36	Flame retardant	36	3
Silicone Rubber	63	5	CSPE	28	2
Kerite	61	5	Butyl rubber	20	2
Polyethylene	52	5	All others		Each ≤ 1%

Numerous standards have been developed over the years to group and categorize cables based on application, voltage, environment, and basic design type (Table 3.2). Exactly what grouping is used depends on the application but for cable aging management, generally the nuclear industry has focused on medium- and low-voltage cables. Low-voltage cables constitute the majority of NPP cables but many safety-critical cables exposed to moisture are medium-voltage cables. Most plants have a rigorous program to test and verify performance of safety-critical medium-voltage cables. Cable CM programs are encouraged through NRC’s Draft Regulatory Guide 1240 (NRC 2010) with particular emphasis on medium-voltage cables sighting examples of cable failures particularly for wet environment cables. Although this is not currently a required program, it is encouraged by the NRC “*to promote discussion between staff and licensees when a facility’s operating experience indicates cable failure or degraded cable performance as a causal factor. The NRC staff will use this guidance to evaluate compliance with the Maintenance Rule.*”

For shielded medium-voltage cables, the $\tan \delta$ electrical test is widely used. Other tests include withstand tests and partial discharge tests even though it may be argued that these tests are or have a risk to be destructive. In many cases, these cables are not easily accessible except at termination points, so bulk electrical tests are the only practical option and local tests may be performed only at the limited accessible locations or with difficulty to access normally inaccessible locations.

Table 3.2. Categories of Cable Grouping

Application	Voltage	Environment	Design
Power	Low (≤ 2 KV)	Normal operating	Single/multi conductor
Control	Medium ($\leq 2-46$ KV)	temperature	Triplex
Instrument	High (>46 KV)	High temperature	Thermocouple alloys
Thermocouple		Fire/flame retardant	Co-Axial
Communication		High radiation	Shielded/ unshielded (and
Specialty Configuration		Submerged – water	shield type – tape, braid,
Safety Related		Aggressive solvents	...)
Non-Safety Related			Special jacket
			Conductor / shield material
			(copper, tinned copper,
			aluminum, ...)
			Insulation/jacket material
			(XLPE, EPR, PVC, ...)

3.3 Recent Cable Test Aging Management Studies and Guidance

A number of relatively recent U.S. and international documents have been written to describe research and provide guidance on implementation of cable aging programs. These include:

- NUREG/CR-7000, BNL-NUREG 90318-2009, *Essential Elements of an Electric Cable Condition Monitoring Program* (Villaran and Lofaro 2010)
- Regulatory Guide 1.218, *Condition-Monitoring Techniques for Electric Cables Used in Nuclear Power* (NRC 2012)
- NP-T-3.6, *Assessing and Managing Cable Aging in Nuclear Power Plants* (IAEA 2012)
- EPRI Low-Voltage Cable Aging Management Course (workbook) (updated 2015)¹

¹ EPRI. 2015. *Low-Voltage Cable Aging Management Course (workbook)*. Electric Power Research Institute, Palo Alto, California.

- EPRI Technical Report 3002000557, *Plant Engineering: Aging Management Program Guidance for Medium-Voltage Cable Systems for Nuclear Power Plants, Revision 1* (Mantey and Toman 2013)
- ADVANCE Aging Diagnostics and Prognostics of Low Voltage I&C Cables Collaborative Project led by Electricity de France, Publishable Summary Report December 2013 (ADVANCE 2013)
- Draft Regulatory Guide 1240, *Condition Monitoring Program for Electric Cables Used in Nuclear Power Plants* (NRC 2010).

Common themes from these reports include the following points:

- **CM assessment to estimate design margins under DBE:** The integrity and function of power, instrumentation, and control cables are monitored indirectly through the performance of in-service testing of safety-related systems and components. These tests can demonstrate the function of the cables under normal operating test conditions. However, such tests do not provide assurance that cables will continue to perform successfully when they are called upon to operate fully loaded for extended periods as they would under normal service operating conditions or under DBE conditions.
- **Multiple complementary test approaches:** A number of test approaches must be employed to reasonably assure the safe operation under the test condition and, by inference, safe operation under a DBE.
- **Continued operation based on condition monitoring:** The basis for justifying aged cables should be periodic condition testing. This is commonly referred to as monitoring and normally does not mean continuous monitoring. This is a practical way to assure cables are performing as designed, thereby justifying leaving them in service after their initial planned useful life.
- **Bulk and local tests:** Bulk end-to-end testing of a cable is preferred, but it is possible and even likely that cable condition can be locally masked by splices, blind spots at termination ends, etc. Test tools can and should include both bulk and local tests.
- **Localization of damage:** Localization of areas of concern is important because practical management of areas of degradation may involve local tests, cable splices and repair rather than replacement of a full cable length.
- **Structured program for aging cable management:** Although the same basic program elements are recommended from most of the above documents, NUREG/CR-7000 (Villaran and Lofaro 2010) outlines a clear nine-step aging management condition-based qualification approach (Table 3.3).

3.4 Project Objectives

The overall objectives of this project are to develop the technical basis for assessing the level and impact of cable insulation aging and degradation in NPPs. The project addresses the overall gaps that were identified at the workshop in FY2012 using a phased approach. This phased approach addresses the three areas identified from the workshop:

1. Determination of key indicators of cable aging. This has largely been addressed in earlier reports (Simmons et al. 2014; Fifield et al. 2015; Ramuhalli et al. 2015).
2. Characterize and advance current NDE methods and develop new NDE methods by using insights from the determination of key indicators. Although the work continues, this is largely addressed in this report.
3. Develop models that use the advances in key indicators and NDE methods to assist in predicting remaining life of cables—ongoing.

Table 3.3. NUREG/CR-7000 Nine-Step Program for Aging Cable Management

Program Element	Purpose	Expected Result
1. Selection of Cables to be Monitored	To identify and select electric cables that are candidates for inclusion in the cable CM program.	A listing of the most important cables in the plant whose condition should be periodically monitored and evaluated to provide assurance that they are capable of performing their intended function.
2. Develop Database of Monitored Cables	To provide a single centralized source of information for all the cables in the program that can be used by the cable engineer as a tool to access, analyze, and evaluate the data and documentation necessary to make cable condition assessments and to guide the direction of program decisions and activities.	A data base that will provide essential information to support the implementation of the cable CM testing and inspection activities and periodic review and assessment of the condition of individual cables.
3. Characterize and Monitor Cable Operating Environments	To verify the baseline design operating environment for a cable, to periodically verify actual environmental conditions, and identify local adverse environments (e.g., high temperature or radiation, moisture, submergence) that may have developed, and to manage environmental conditions to mitigate the effects on cables	Baseline environmental operating conditions measurements and inspection results, periodic environmental CM and verification measurements and results, identification and description of local adverse environments, and activities for managing operating environments to mitigate adverse effects on cables.
4. Identify Stressors and Aging Mechanisms Affecting Cables in the Program	To identify the stressors and determine the aging mechanisms affecting cables in the program	Listing of the stressors and aging mechanisms affecting the condition of each cable in the program to be used in program element 5 to select the most effective CM inspection and testing techniques for each cable.
5. Select CM Inspection and Testing Techniques	To determine the most effective CM inspection and testing techniques to detect and monitor the anticipated aging/failure mechanisms for each cable	An initial listing of cable CM inspection and testing techniques and periodic performance frequency for each cable.
6. Establish Baseline Condition of Cables in the Program	To measure and document the baseline condition of each cable in the program using the selected cable CM inspection	Baseline cable condition measurements and inspection results for the techniques selected in program element 5.
7. Perform Periodic CM Inspection and Testing	To periodically measure and document the condition of each cable in the program using the selected cable CM inspection and testing methods identified in the program element 5	Periodic record of cable condition measurements and inspection results for the techniques selected in program element 5.
8. Review and Incorporate Cable-Related Operating Experience	To review industry-wide and in-plant cable-related operating experience and incorporate changes to the cable CM program as required to address applicable issues and trends	Incorporate changes to the cable CM program based on review of applicable operating experience.
9. Periodic Review and Assessment of Cable Condition	To perform a periodic review of the current cable condition CM inspection and testing results, operating environments CM results, trends of cable properties and condition measurements, and applicable operating experience to establish an up-to-date assessment of cable condition, expected service life, and program changes and activities to manage aging	A formal periodic assessment of cable condition, expected service life, and program changes and activities to manage aging degradation of each cable in the program.

4. THERMAL AND RADIATION ACCELERATED AGING, PLUS ELECTRICAL TEST BED

The principle concern for adverse environments experienced by polymer insulated/jacketed electrical cables in NPPs is elevated temperature and radiation. Typical NPP temperatures and dose allow cables to operate for an undetermined amount of time. All we know is that, given assumed maximum dose over initial licensed period, and anticipated dose/temperatures under DBE, the cables will continue to perform their intended function. Based on time-limited aging analyses and available information on actual dose/temperatures, industry and regulators are reasonably certain that the cables will perform well under DBE through first license renewal period (60 years). Thereafter, material degradation is of sufficient concern to warrant specific tests and repair or replacement if necessary. Cable aging studies require the ability for accelerated aging of cable materials. Moreover, there is evidence that sequential thermal and then radiation-accelerated aging may not be conservative for EAB analysis compared to simultaneous thermal and radiation-accelerated aging.

Accelerated thermal aging of cable segments and cable materials at PNNL are performed in temperature-controlled, forced-air ovens equipped with multiple thermocouples for temperature data monitoring and recording. The ovens can accommodate pass-through cable segments as well as racks supporting polymer samples (Figure 4.1).



Figure 4.1. Accelerated Cable Aging Oven with Rack of Test Polymers and Pass-Through Cables

A radiation chamber is also available for radiation-accelerated aging with ^{60}Co sources capable of exposures to 6K curies (Figure 4.2). This radiation chamber can house up to three ovens for combined thermal and radiation aging.



Figure 4.2. ⁶⁰Co Gamma Radiation Chamber Capable of up to 6K Curies for Cable Aging Studies

PNNL has also developed a test setup that can thermally age the cable while cable property measurements are performed. The setup allows a segment of the cable to be subjected to thermal aging and electrical load (Figures 4.3 and 4.4). If the CM approach can be performed while the system is operating, then the test may be conducted without opening the oven or interrupting the electrical load.

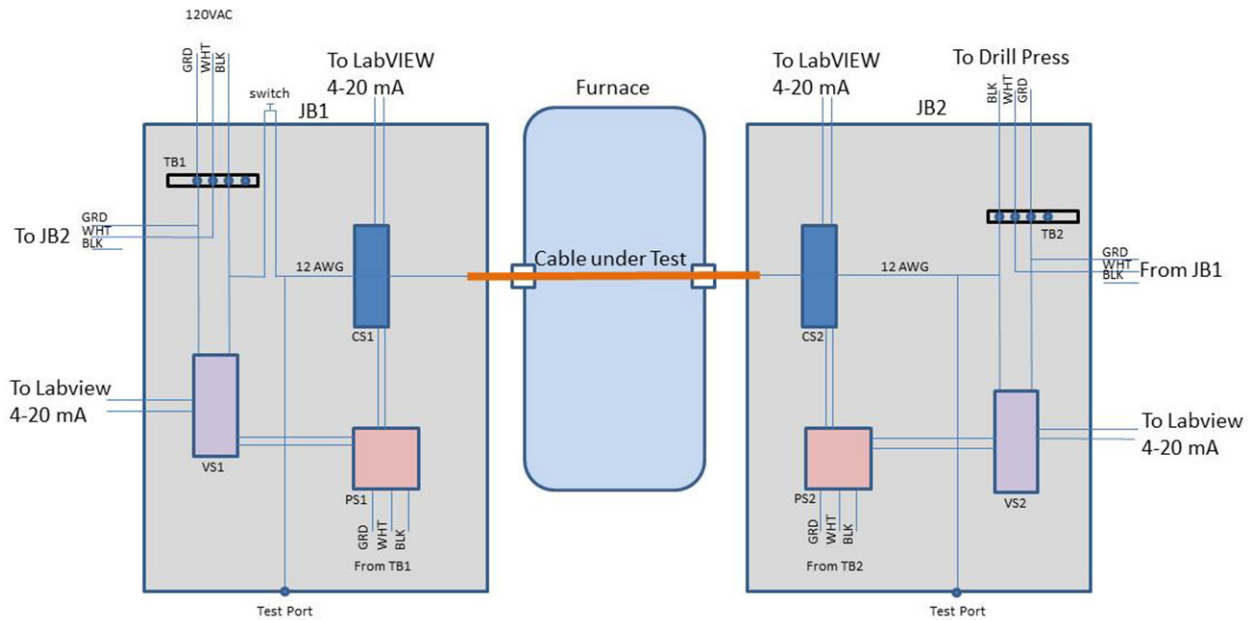

Figure 4.3. Graphic Representation of Measurement Circuit (where JB – Junction Box, TB – Terminal Block, CS – Current Sensor, VS – Voltage Sensor, PS – Power Supply)



(a)



(b)

Figure 4.4. Photograph Showing the Cable Aging Test Bed. The load (motor) is on the right of the oven and the integrated control system is on the left.

5. BULK ELECTRICAL MEASUREMENTS

Bulk electrical tests enjoy several advantages over local tests including:

- Testing electrical characteristics that are most closely associated with cable function.
- They test the entire cable assembly.
- Tests are performed at termination locations that are well known and reasonably accessible.
- Some test methods also point out locations of weaknesses that may be candidates for local tests.
- Many bulk electrical tests have clear recommended acceptance criteria that justify decisions to leave the cable in service, schedule for replacement, or replace/repair immediately.

Details of bulk electrical tests are varied and fall into several categories as outlined in Table 5.1, taken and paraphrased from the International Atomic Energy Agency (IAEA) Nuclear Energy Series *Assessing and Managing Cable Aging in Nuclear Power Plants* (IAEA 2012), a recent workshop *Light Water Reactor Sustainability (LWRS) Program – Non-Destructive Evaluation (NDE) R&D Roadmap for Determining Remaining Useful Life of Aging Cables in Nuclear Power Plants* (Simmons et al. 2012), and NUREG/CR-7000 (Villaran and Lofaro 2010).

Table 5.1. Available Common Techniques for Bulk Electrical Cable Inspection

Inspection Method	Advantages	Disadvantages
Time-Domain Reflectometry	Commonly used for determining the condition of instrumentation, control, and power cable conductors where full-length cables are relatively inaccessible. Test uses low voltages and is completely nondestructive.	Intrusive – requires disconnecting at least one end of the cable perform the test. Only tests conductor. Not sensitive to insulation damage.
Frequency Domain Reflectometry	Low voltage, tests full cable including insulation, can identify flaw location	Intrusive – requires disconnect. Works best for shielded cables. High noise on unshielded cables. Data interpretation challenging.
Partial discharge	Stepped high voltage test (to $2U_0$) that identifies cable weakness up to the point of insulation break-down	May damage weak or compromised cable and potentially can cause noise and damage near-by circuits. Also does not locate discharge location.
Insulation Resistance (low voltage)	Commonly performed in industry to determine the condition of the cable insulation. – primarily as a screening for other tests	Inconsistent readings weaken broad acceptance of this test.
Inductance/Capacitance / Resistance	Good for detecting changes in electrical circuit (cable and termination) by trending changes in inductance, capacitance, and resistance.	Currently intrusive, requires disconnecting cable at one end. Does not indicate location or cause of change in measurement.
Tan Delta ($\tan \delta$)	Determines changes in insulation (dielectric) properties by measuring change in dielectric loss angle. Can measure aging effects over entire cable length.	Intrusive, requires decoupling both ends. Only suitable for shielded cable and no information regarding degradation location of aged or damaged segment. Loss angle may be trended; however, single measurement insufficient to estimate remaining life.

5.1 Time Domain Reflectometry

A time domain reflectometry (TDR) measures reflections of a stepped or impulse signal along a single conductor to detect and locate any changes in the conductor impedance. In order to measure those reflections, the TDR transmits an incident signal onto the conductor and listens for its reflections. If the conductor is a uniform impedance network and is properly terminated to matching impedance, then there will be no reflections and the transmitted signal will be completely absorbed at the far end by the termination. Instead, if there are impedance variations as in a short or open at the cable end, or a damaged or reduced cross-sectional area or a splice with a higher resistance along the conductor, then some of the incident signal will be reflected back to the source. This reflected signal can be associated with distance along the cable equal to the velocity times the propagation time. The amplitude of the reflected signal coupled with the inherent cable attenuation characteristics also allows an estimate of the magnitude of the impedance change.

TDR testers are portable units that can easily be used in-situ within an NPP. The test is a low-voltage test so there is virtually no risk to the cable. The main emphasis, however, of a TDR test is to assess the condition of anomalies in the conductor, and very little information is provided regarding subtle changes in the insulation. Locations of conductor anomalies, however, could be good indications for supplemental local tests of the jacket and insulation.

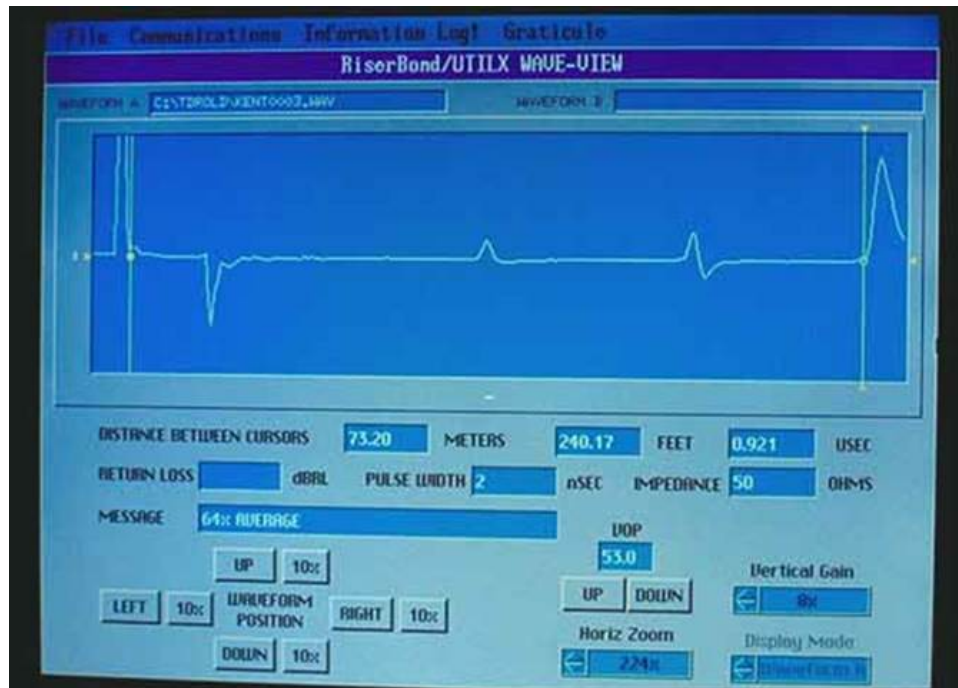

Figure 5.1. Typical TDR Graph Showing Cable Ends (at cursors) Plus Three Reflections of Terminations, Splices, or Field Penetrations in Between

5.2 Tan δ Measurements

The tan delta technique or tan δ can be derived from one of Maxwell's four equations, which relates the magnetic field intensity to the electric field intensity. Expressed in phasor form, the equation contains the relationship between the conduction current density ($\sigma\mathcal{E}$) and the displacement current density ($j\omega\epsilon'\mathcal{E}$) for dielectric materials (Simmons et al. 2014).

$$\nabla \times \mathcal{H} = \sigma\mathcal{E} + j\omega\epsilon'\mathcal{E} \quad (\text{Am}^{-2}) \quad (5.1)$$

where: \mathcal{H} = magnetic field intensity (A/m)
 \mathcal{E} = electric field intensity (V/m)
 σ = conductivity (U/m)
 ω = angular frequency (rad/sec)
 ϵ' = real portion of the complex permittivity where $\epsilon = \epsilon' - j\epsilon''$ (F/m)

The relative permittivity ϵ_r describes how a specific material will interact with an applied electric field. Known as the dielectric constant of the material, it is derived from the permittivity of free space $\epsilon_0 = 8.854 \times 10^{-12}$ F/m where $\epsilon = \epsilon_r \epsilon_0$.

This complex permittivity can therefore be written as $\epsilon_r = \epsilon'_r - j\epsilon''_r$ and shown on a simple vector diagram (Figure 5.2).

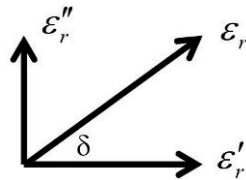

Figure 5.2. Phasor Relationship between the Real and Imaginary Components of Permittivity

The tangent of the angle δ between them is the ratio of these two vector quantities and is a measure of the ratio of energy from the applied electric field that is stored in a specific material to the amount dissipated or lost. This quantity is known as the loss tangent and defined as:

$$\text{Tan } \delta = \frac{\epsilon''_r}{\epsilon'_r} \quad (5.2)$$

The cable to be tested must be de-energized and each end disconnected and isolated. The network analysis is between the conductor and the shield. Using a very low frequency (0.1 to 1 Hz) AC Hipot, the test voltage is applied to the cable while the $\tan \delta$ controller takes measurements. Typically, the applied test voltage is raised in steps, with measurements first taken up to 1 Uo, or normal line to ground operating voltage. If the $\tan \delta$ numbers indicate good cable insulation, the test voltage is raised up to 1.5–2 Uo. The $\tan \delta$ numbers at the higher voltages are compared to those at lower voltages and an analysis is made. Commercial instruments are available to perform $\tan \delta$ testing. These units are reasonably light-weight (<30 kg for a 34 kV unit) and portable and can be taken into an NPP for in-situ tests (Figure 5.3). $\tan \delta$ testing is beginning to be widely used in NPPs—particularly for medium-voltage shielded cable. Such tests have been shown to be particularly sensitive to water tree degradation in medium-voltage cables (Mantey and Toman 2013).

With a marginal or damaged cable, there is a possibility for cable failure with a $\tan \delta$ test because the voltage potential is elevated above normal line voltage; however, cables typically have a comfortable safety factor well above the test voltage. $\tan \delta$ tests are not considered destructive and certainly pose less stress on the cable than withstand tests or partial discharge tests. EPRI and manufacturers have developed recommended guidance for acceptance thresholds for some cables, but sensitivity and reliability is best if used as a regular periodic test where results can be compared to baseline data and trended.



Figure 5.3. Tan Delta Model 34K. Photo provided by High Voltage, Inc.

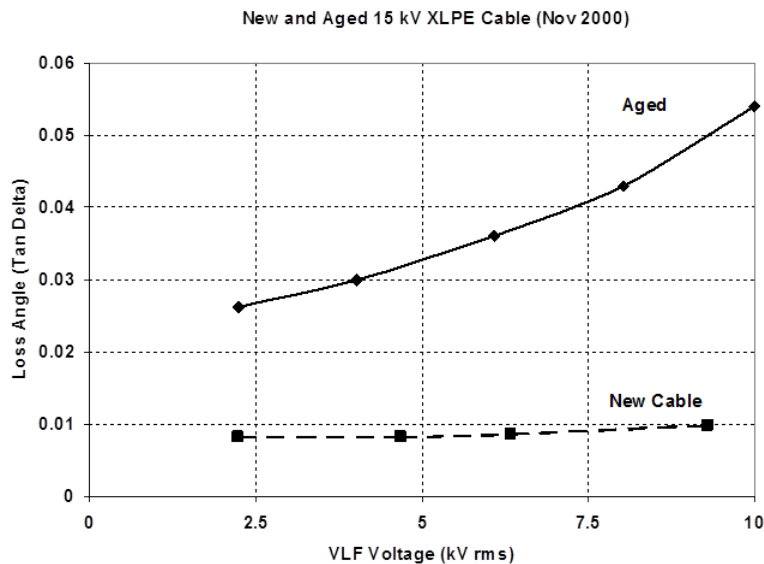

Figure 5.4. Example Tan Delta Test Result of New and Aged Cable. Graphic provided by High Voltage, Inc.

5.3 Frequency-Domain Reflectometry

Frequency-domain reflectometry (FDR) is a nondestructive electrical inspection technique used to detect and localize faults in power and communication system conductors along the length of a cable from a single connection point. For the measurement, two conductors in the cable system are treated as a transmission line, which propagates a low-voltage swept-frequency waveform to interrogate the cable length. Note that because the applied signal is low-voltage (<5 volts), the test is completely nondestructive and poses no special safety concerns to operators. An inverse Fourier transform is used to convert the resulting frequency-domain data into a time-domain format, which can determine the physical location of signal reflections if the signal propagation velocity is known.

FDR has inherent advantages that can yield better sensitivity to cable insulation degradations than traditional TDR, which is limited to identifying open and short circuit conditions in the conductors and in some cases splice locations (Murty 2013). FDR is also less susceptible to electrical noise and interference because of the availability of filtering and noise-lowering algorithms in the frequency domain (IEC 2002).

FDR detects discontinuities in the electrical impedance that arise from cable splices or similar changes along the path of the conductor pair. In addition, FDR has the potential to provide sensitivity to insulation degradation by detecting small changes in capacitance between the cable conductors being

examined. Example changes that impact the insulation capacitance include exposure to heat, radiation, water damage, corrosion, or mechanical fatigue. A previous interim report (Ramuhalli et al. 2015) showed that the dielectric properties of EPR insulation specimens changed as a function of aging. It is likely that any changes in polymer dielectric properties with age will contribute to measureable changes from an FDR measurement.

5.3.1 Simulated Cable Defects

A simulator module in a commercially available FDR-based system was used to study detection sensitivity to local cable degradations as a function of small changes in the local electrical properties of two different cable systems. The first cable configuration was a 50-ohm RG-58 type coaxial cable with a nominal insulation dielectric constant of 2.25, and the second configuration was a twisted pair with 16 AWG conductor diameters. The simulated defects were modeled as 1-inch and 6-inch cable segments with different dielectric constants or capacitance than the other sections of the cable. Separate additional simulations were used to study the effects of simulated white noise produced by waveform generator electronics circuits on the theoretical sensitivity.

Figures 5.5 and 5.6 show the simulated results for a 1-inch and 6-inch defect placed at 200 ft. in a 500 ft. RG-58 coaxial cable without and with the presence of white noise. In this case, a greater than 10 dB reflection was produced for a 0.02 percent change in the dielectric constant for the 1-inch defect and for a 0.003 percent change in the dielectric constant for the 6-inch defect. The plots also show the large reflection produced by FDR at the termination end of the cable. In this simulation study, the end of the cable was terminated in a very large resistance representing an open circuit condition. Typically a reflection will exist at the opposite end of the conductor pair under test because of an impedance mismatch with the cable characteristic impedance. Unless measurements are performed from both ends of the cable, defects may be hidden inside this region.

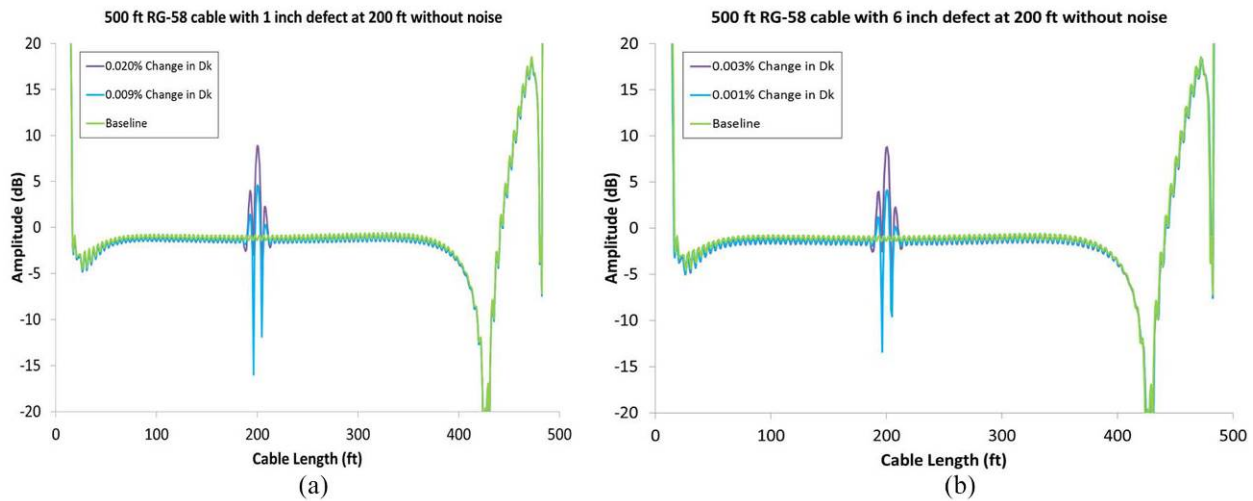

Figure 5.5. Simulated FDR Responses without White Noise for RG-58 Coaxial Cable with (a) 1 in. Defect Located at 200 ft.; (b) 6-inch Defect at 200 ft. without Noise

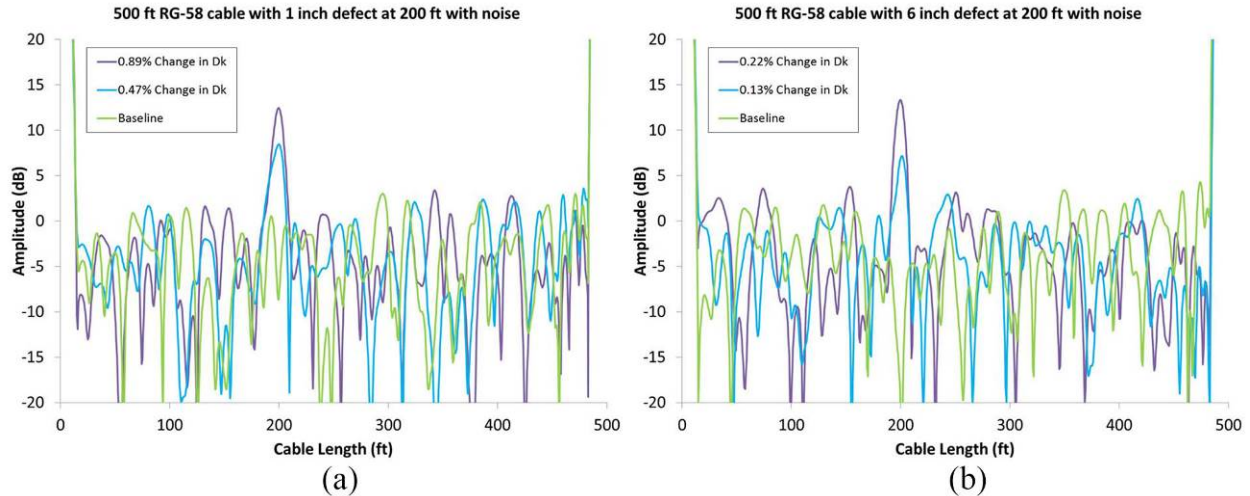

Figure 5.6. Simulated FDR Responses with 0.5% White Noise Level for RG-58 Coaxial Cable with 1-inch (a) and 6-inch (b) Defects Located at 200 ft.

Similar simulation results were obtained for a simulated defect placed at 100 ft. along a 400 ft. twisted pair cable (Figure 5.7). Practical field limitations, however, are acknowledged (Fantoni 2007) in the literature noting limited efficacy of the tests for unshielded cable due to environmental noise.

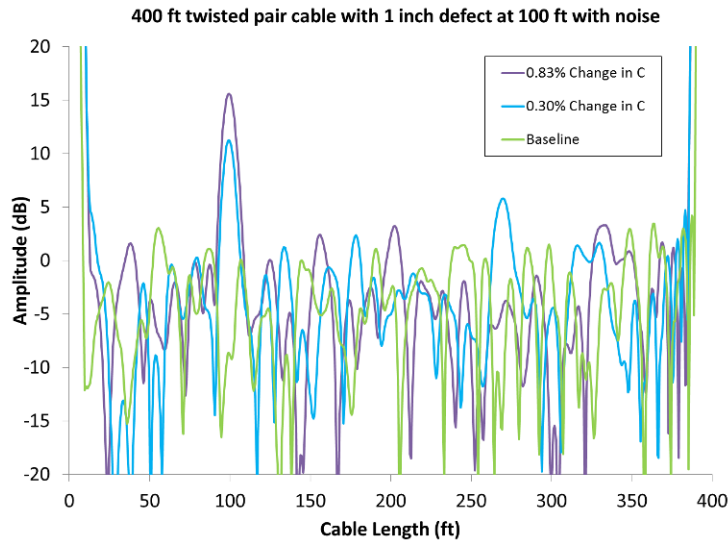

Figure 5.7. Simulated FDR Responses with 0.5% White Noise for Twisted Pair Cable with 1 inch Defect Located at 100 ft.

5.3.2 Mechanical Cable Defects

An FDR instrument was applied to an unshielded triplex 14 AWG stranded copper conductor cable. FDR spectra were taken among all conductor pairs—red-black, red-blue, and black-blue (Figure 5.8). The cable was evaluated both in simulation and empirically as shown in Table 5.2 and Figures 5.9 through 5.14. Based on this limited test, FDR cable testing offers a powerful tool to identify cable weak spots—particularly for shielded cable. Noise levels are high for unshielded cable and so the FDR application is less useful and generally must be based on comparison to baseline data. The manufacturers of the instruments also caution to expect high noise levels from unshielded cable. Additional FDR testing is planned to further verify applicability to additional cases including mechanical, thermal, and radiation damage to this and other configurations of cable.

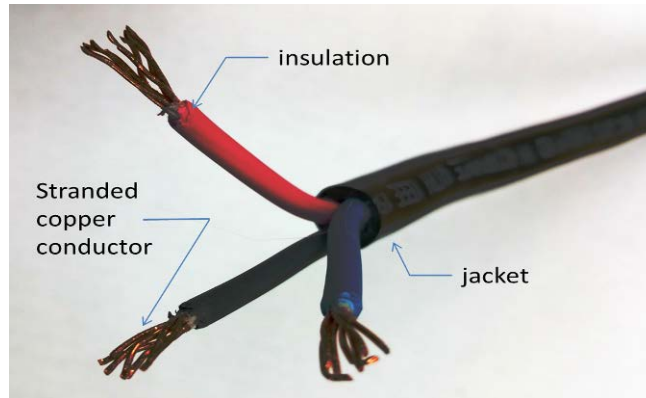

Figure 5.8. General Construction of Okonite-FMR Okoseal Type Triplex Cable

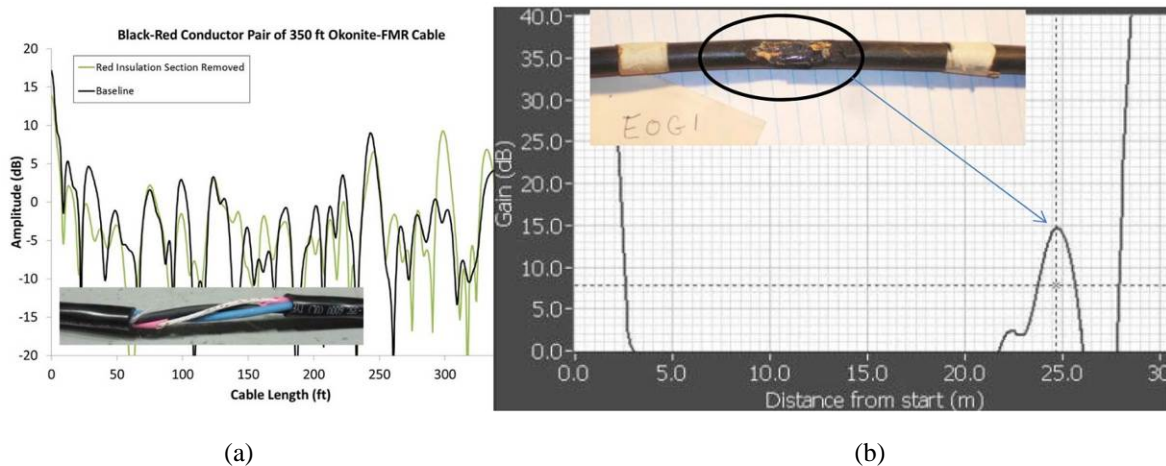

Figure 5.9. FDR Response Spectra for: (a) Unshielded Triplex Cable Before and After Insulation Removal from One Conductor at 300 ft.; (b) Shielded Cable with Shield Insulation Abraded at 25 m

Table 5.2. FDR Test and Simulation Conditions and Observations

Condition	Observation
200 ft. undamaged cable simulation	Unrealistic without noise compared to real data.
200 ft. cable with 1 inch of insulation removed from one conductor simulation with and without noise	Detectable, but signal level similar to noise level. Implies OK to compare to baseline, but difficult without baseline.
200 ft. cable with 6 inches of insulation removed from one conductor simulation with and without noise	Signal is slightly larger, but conclusion is similar to 1 inch removed simulation as above.
350 ft. cable with two 180-degree reversals (without extremely small bend radii) at 145 and 230 ft.	Cable reversal locations observed. Indicates signal is sensitive to cable shape.
350 ft. cable with 2.5 inches of jacket removed at 300 ft.	No difference in before and after jacket removal.
350 ft. cable with 2.5 inches of insulation removed at 300 ft.	Removed insulation detectable, but similar size signal to noise. Would not be detectable without baseline.
Shielded 14AWG stranded cable (compared from EPRI report) with abraded shield insulation	Shielded cable produced much lower noise. Cable damage clearly detectable independent of baseline except at extreme cable ends where blind zone expected.

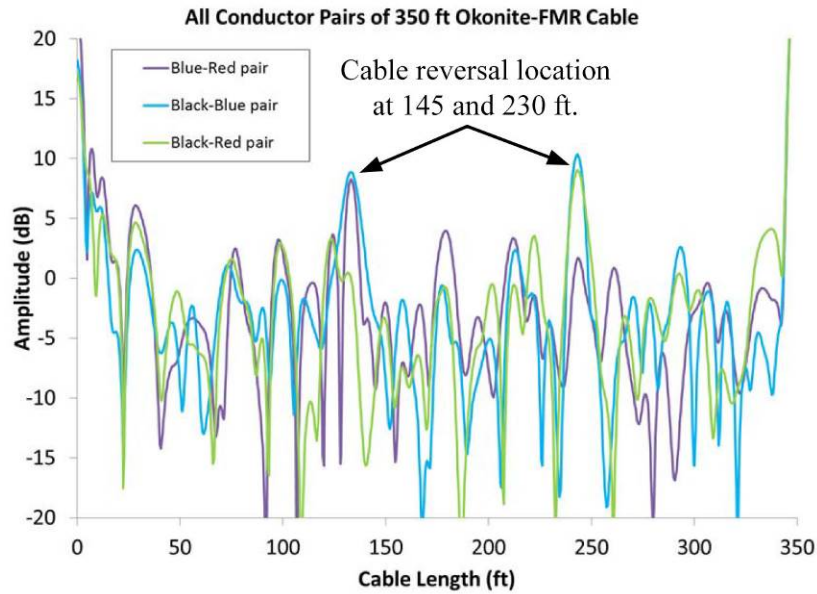

Figure 5.10. Measured FDR Responses for 350 ft. Length of Brand New Okonite-FMR Cable

A 2.5-inch section of the cable outer jacket was carefully removed from the cable at 300 ft. from the measurement connection point as shown in Figure 5.11. The overall cable routing layout was not modified during the removal of the jacket. The cable was again measured to compare with the baseline data and to inspect for any apparent differences at the damaged location (Figure 5.12). No clear differences were noted between before and after jacket removal at the 300 ft. location. The conclusion from this comparison is that degradations that are confined to the cable jacket may not produce capacitive changes significant enough to be confidently identified with an FDR inspection measurement.



Figure 5.11. Okonite-FMR Cable with 2.5-inch Section of Jacket Removed at 300 ft.

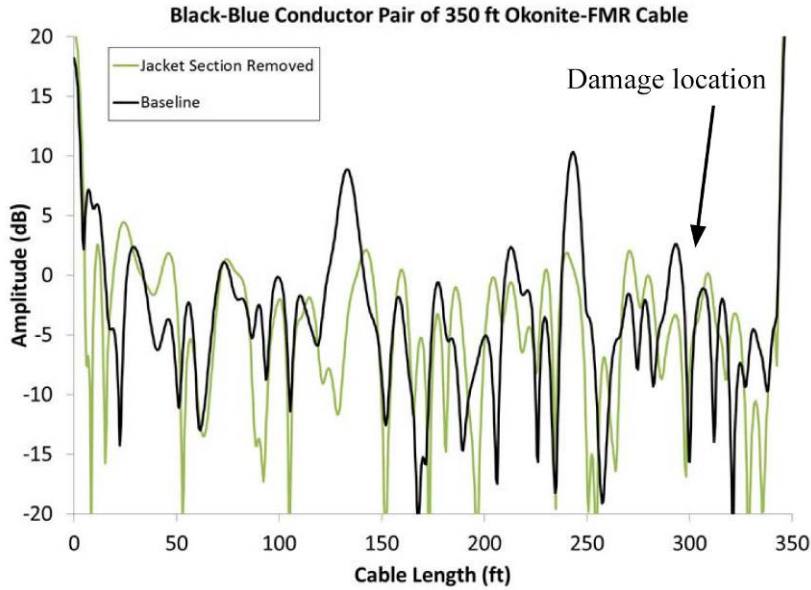

Figure 5.12. FDR Measurements of Black-Blue Conductor Pair in 350 ft. Okonite-FMR Cable with 2.5-inch Jacket Section Removed at 300 ft.

The red EPR insulation around its conductor was then removed at theunjacketed location in order to continue measurements of local mechanical damage along the cable. Figure 5.13 shows the cable with the red insulation and jacket removed at 300 ft. The cable was re-measured to compare with the baseline data and to inspect for any apparent differences at the damaged location. Figure 5.14 shows the results for the black-red FDR with the largest peak difference between baseline and insulation removal at the 300 ft. location. Responses were similar for blue-red; however, predictably the blue-black FDR showed little or no difference at the damage location. The conclusion of this comparison is that the removal of conductor insulation can produce capacitive changes large enough to be readily detected with an FDR inspection when the measurement is performed for conductor pairs directly affected by the insulation removal.

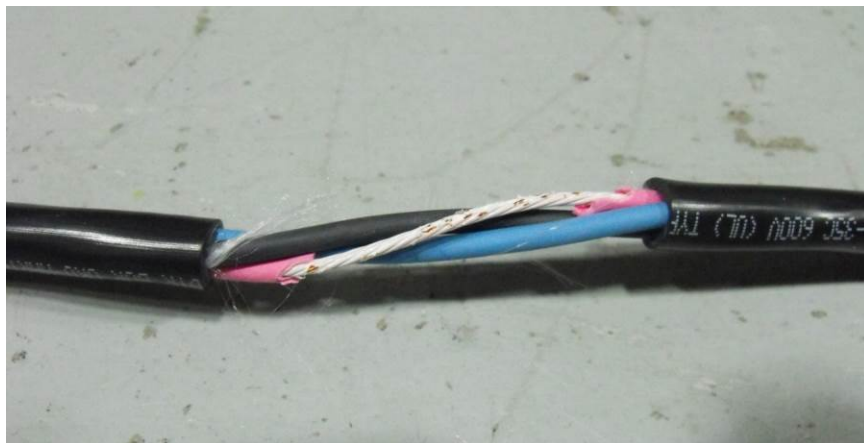

Figure 5.13. Okonite-FMR Cable with 2.5-inch Section of Jacket and Red Wire Insulation Removed at 300 ft.

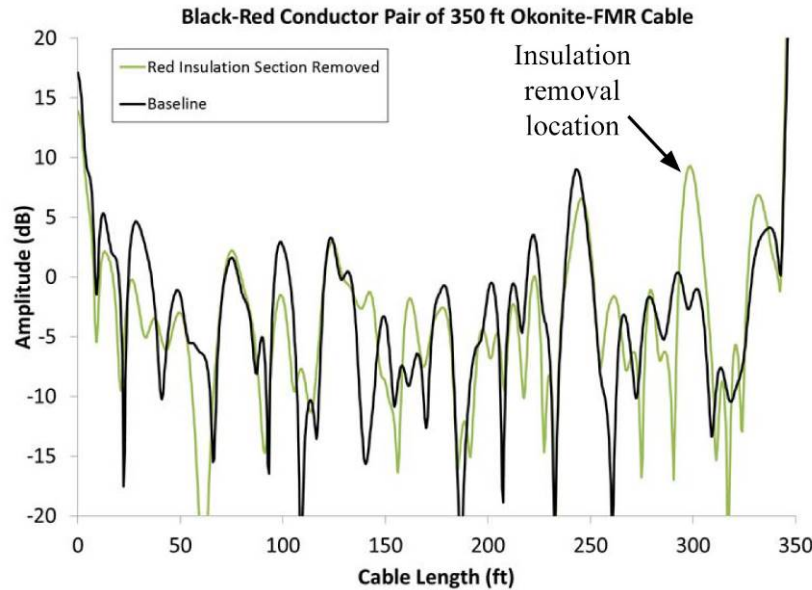

Figure 5.14. FDR of Black-Red Conductor Pair in 350 ft. Okonite-FMR Cable with 2.5-inch Section of Jacket and Red Wire Insulation Removed at 300 ft.

The insulation removal resulted in a similar order of magnitude change as the peaks associated with the cable reversal. Moreover, the noise level in this cable would make any analysis without a baseline for comparison challenging. The influence of cable bends may not be such a problem if a baseline exists because the cable is unlikely to be moved or re-routed between measurements.

A series of FDR measurements is planned for the PNNL test bed (Section 4) to better quantify the influence of mechanical insulation pinch, cable routing, temperature, and other non-age-related parameters as well as thermal and radiation-aged sections of cable.

5.4 Partial Discharge

Partial discharges (PDs) are electrical discharges that can take place in gaseous inclusions, which may accidentally occur in solid insulation. PDs do not bridge the whole insulation (i.e., they do not extend from conductor to ground) but can lead to ultimate failure. A PD takes place in a nanosecond and causes high-frequency currents, which are measurable by PD detection equipment to flow in the external circuit. After a discharge, both positive and negative charges are deposited on the surfaces of the voids or tree channels. These charges change the localized electrical field, thereby controlling the time when the next PD will take place along with the change in field from the sinusoidal voltage applied. The net result is that a pattern of PDs of various magnitudes, repetition rates, and phase angles relative to the applied voltage can be seen. During testing in which the voltage is slowly raised, the voltage at which discharges are observed in each cycle is known as the PD inception voltage. On decreasing the voltage slowly from above the PD inception voltage value, the voltage at which PD ceases is referred to as the PD extinction voltage. PD will often become intermittent before complete extinction occurs. Because of the deposition of charges on the surfaces of the voids caused by PD, the PD extinction voltage can theoretically be as low as 50 percent of the inception voltage. In practice, the difference is between 10 and 25 percent. To ensure that a cable is discharge-free at the operating voltage, it is necessary to test for PD at levels up to twice the operating voltage. Decreases in the PD inception voltage are an indication of significant degradation of the insulation material. A cable that has PD at operating voltage or within 1.5 times the operating voltage is generally significantly deteriorated and may fail in the near future. Cables that have no significant PD at levels up to twice the operating voltage have no immediate expectation of failure from PD and will operate satisfactorily for a significant period of time.

Modern PD detection equipment can provide three-dimensional plots showing the phase, magnitude, and number of PDs. From the characteristics of these plots, it may be possible to identify the source of the PD (e.g., from spherical or flat cavities or voids, electrical trees, or interfaces). The PD test is potentially damaging because the discharges induced can cause degradation of the insulation over a period of time from localized overheating. This test has limitations for use in the field because it requires relatively high voltages to be applied to the cable, which would be a concern due to the potential for damaging the cable or surrounding equipment. As a result, PD is typically performed on medium-voltage cables. Additionally, nearby operating electrical equipment in a plant environment could interfere with the test because of noise interference, so this test is most successful on shielded cables.

6. LOCAL MEASUREMENTS

Bulk electrical measurements examine the entire cable and in some cases can identify the location of cable insulation weaknesses, but evaluation of the actual area of weak or aging insulation requires local measurements. In many cases, the location of the weakness is not readily accessible or must be inferred from a priori knowledge of the cable environment (proximity to hot pipes or vessels, exposure to high radiation sources, moisture or chemical exposure). Much can be learned from careful observation of cable jackets and insulation through careful informed walk-downs of the visibly accessible areas. Plant operators and EPRI have developed training modules that emphasize what to look for and where to look for cable damage as part of their aging cable management program. Subjective indications of cable degradation, however, are insufficient for most NPP programs where a quantitative indication of cable condition is desired. Local measures of cable condition include the following methods (Table 6.1), each of which is discussed in more detail in subsequent sections.

Table 6.1. Available Common Techniques for Local Cable Inspection

Method	Advantage	Disadvantage
IR spectroscopy	Sensitive to chemical changes on the jacket and outer surface	May over-predict jacket or surface damage not indicative of full volume condition. Also sensitive to surface condition.
Visual walk-downs	Simple and low cost	Not quantitative
Elongation at break	Strongest direct indication of aging damage	Not really a nondestructive technique
Indenter	Simple test that is broadly accepted	Does not work well for harder cables like XLPE
Dynamic mechanical analysis (DMA)	Promising and potential for broader application than indenter	Although it could be adapted to in-situ test, currently a laboratory approach
Interdigital capacitance	Promising and seems to have broad application	Not fully commercial
Ultrasound velocity	Works well for some materials, particularly jacket materials	Not easily adapted to in-situ field measurement and does not work well for some materials
Imbedded micro sensor	Could be an easy test as a leading indicator of damage	Too late to retroactively install in existing cable systems

6.1 Fourier Transform Infrared Spectroscopy

Oxidation and crosslinking of cable insulation polymers such as EPR and XLPE inherently introduce new chemical bonds within the material, including C=O carbonyl and C=C carbon bonds, that have unique vibrational frequencies. A convenient method, therefore, for characterization of related polymer degradation is Fourier transform infrared (FTIR) spectroscopy. Although the example shown below uses a laboratory instrument only suitable for small powdered samples, FTIR can be performed in field settings with portable instruments so that in-situ tests can be envisioned.

An extreme example FTIR spectrum of EPR is provided in Figure 6.1. Pink EPR cable insulation material was milled into a powdered, particulate form and aged in a circulating air oven at 140°C to investigate chemical property changes in a form of the material easier to characterize than full-intact insulation. FTIR absorption peaks associated with unsaturated carbon bonds in the as-produced EPR (2800–3000 cm⁻¹) were observed to decrease with aging of the material at 140°C in air, and new peaks

associated with carbonyl ($\sim 1700\text{ cm}^{-1}$) and hydroxyl groups ($3000\text{--}3500\text{ cm}^{-1}$) were observed to appear. The contrasting spectra are also provided. These changes in infrared absorption with cable aging provide a method to assess the extent of cable degradation. In-situ results would be less dramatic as the influence of oxidation would be sensitive to surface proximity; however, the technique's sensitivity to chemical changes in the material is dramatically demonstrated in this example.

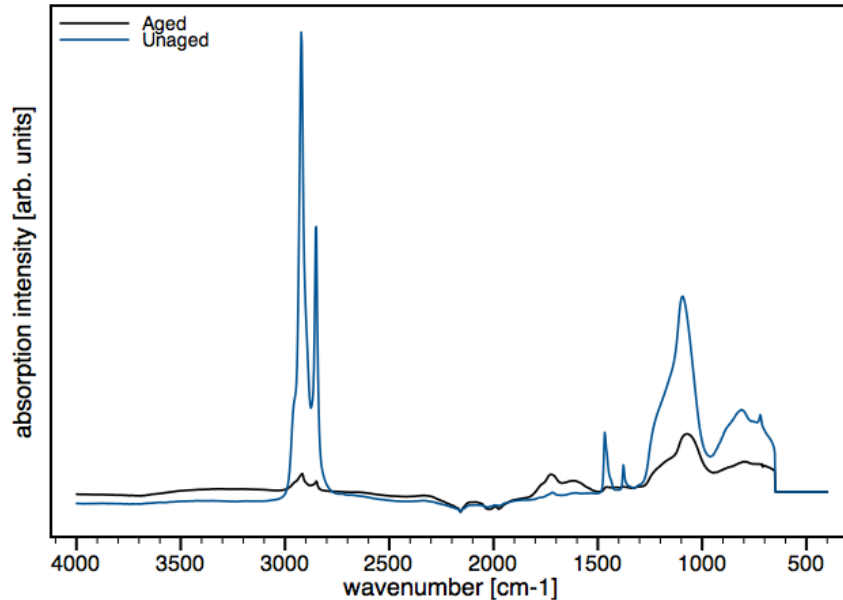

Figure 6.1. FTIR Spectra of Aged and Un-aged EPR

6.2 Visual Walk-Downs

Visual inspections of accessible cable can be a strong leading indicator of cable condition. EPRI includes advice in their cable aging management course advising what to look for and where to look. Cable jackets typically degrade more rapidly than underlying insulation and can be a strong indicator of degradation. Areas that are most susceptible include cable sections near hot vessels and pipes, regions with high radiation exposure, regions with small bend radii, cable trays and supports where cables may be pinched or kinked, and areas where moisture or other chemicals can contact the cable surface. Tell-tail signs of degradation or damage include mechanical abrasion, cracks, and discoloration. For energized cable, the visual walk-down can be supplemented with infrared cameras looking for hot spots. The principal problem with this approach is its subjective nature that does not lend itself well to quantitative assessments or logging of trendable metrics of the cable condition. Moreover, a high percentage of the cables are not readily accessible for viewing and inspection without scaffolding or special access.

6.3 Elongation at Break

The most common measurement for sensitivity to aged conditions is destructive tensile testing known as EAB. Tensile strength may increase during initial aging and then dramatically decrease with some insulators. This has been accepted as the gold-standard for cable insulation aging evaluation because it seems to be most closely associated with the mechanical damage mechanism of concern in a DBE. During PNNL's cable aging study program, a large number of witness samples were created to benchmark other NDE techniques (Figure 6.2). However useful in research, destructively extracting samples from operating NPP cables, is not practical for in-use cables to determine their aged condition (Gillen et al. 1999). It may be possible to apply such techniques to harvested cables or cables that have failed certain criteria and therefore were removed for replacement.

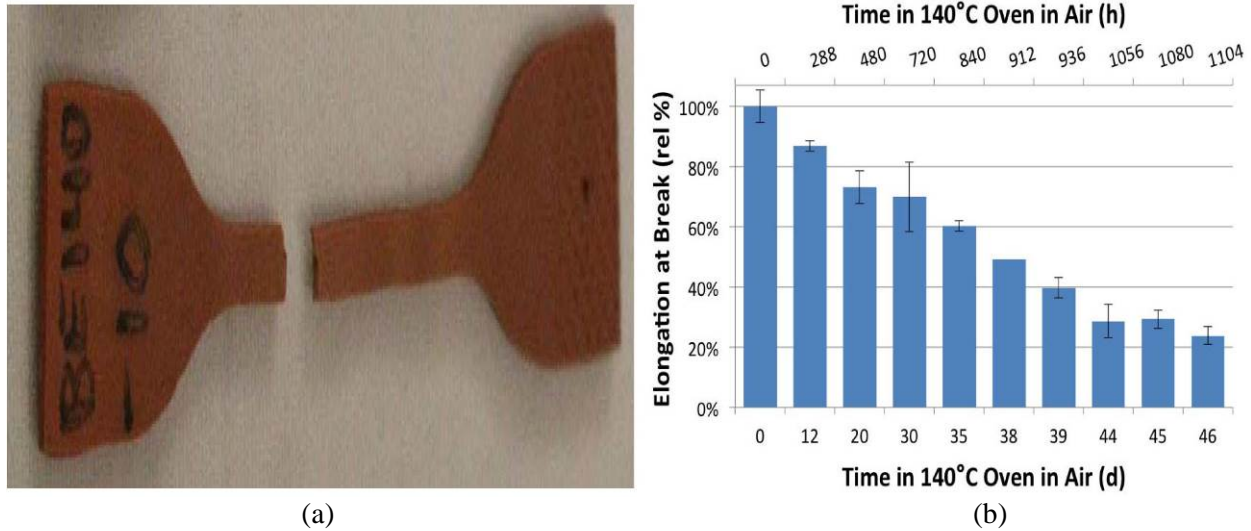

Figure 6.2. (a) Elongation at Break Dog Bone Sample; (b) EAB for Aged EPR Samples

6.4 Indenter

One of the key indicators that has previously been discussed (Yamamoto and Minakawa 2009) is the change in modulus of elasticity of the outer sheath material of a nuclear-grade cable. Aging of polymers used as cable insulation and jacket materials typically causes them to harden, thereby changing their elastic modulus.

Several approaches to measuring elastic modulus (or quantities that are related to the modulus) are possible. Largely due to ease of use and positive reviews by the IAEA (IAEA 2012) and EPRI (EPRI 2005), the indenter has become a broadly accepted industry standard test for cable aging and EAB. The indenter is a portable instrument that can readily be taken into NPPs for in-situ local measurements of the cable jacket and insulation combined (Figure 6.3). The indenter modulus (σ) is simply a ratio of the change in force (ΔF) divided by the displacement (ΔX) where the displacement is delivered at a carefully controlled speed (typically 5 mm/min.).

$$\sigma = \Delta F / \Delta X \quad (6.1)$$

Care must be taken when using the indenter measurement to compensate for temperature changes if the room is not at nominal room temperature (20°C). This measurement also produces a simple value that can be evaluated against nominal acceptance values for each material. Typical programs, however, require logging the indenter modulus values for potential trending analysis.

Initially the indenter instruments focused on measuring the force as the indentation was being made. More recently, however, it has been discovered that the recovery time of an indentation provides significant additional information that may correlate better to aging EAB (Guerout et al. 2009).

For most cable materials and particularly including softer materials like EPR, the indenter modulus increases with aging (Figure 6.4) and correlates well with changes in EAB. The method is not appropriate however for harder materials like XLPE, which show little change in modulus with aging.

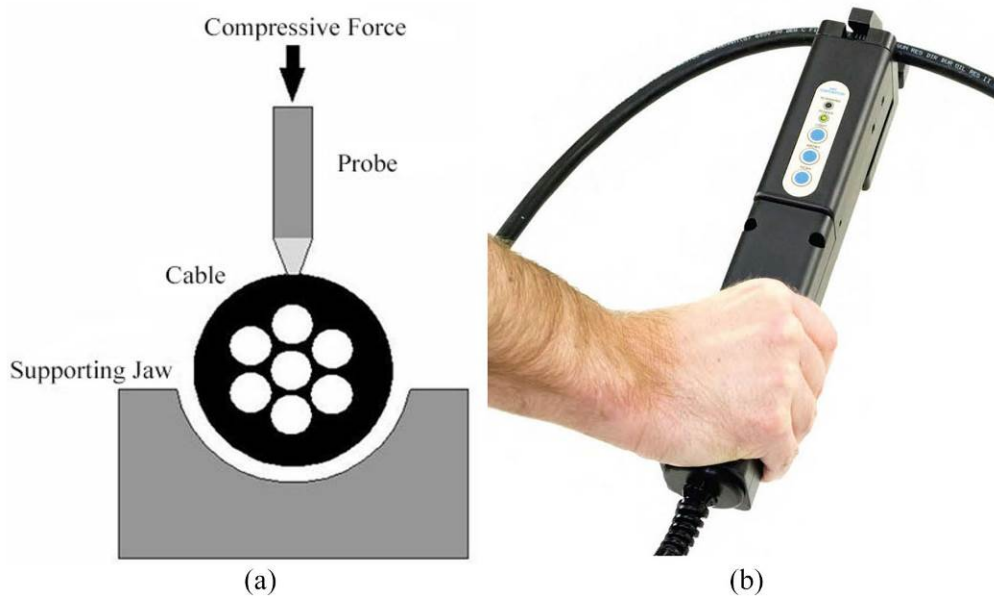

Figure 6.3. Indenter Concept (a) and Actual Tool (b). Photo courtesy of AMS Corporation.

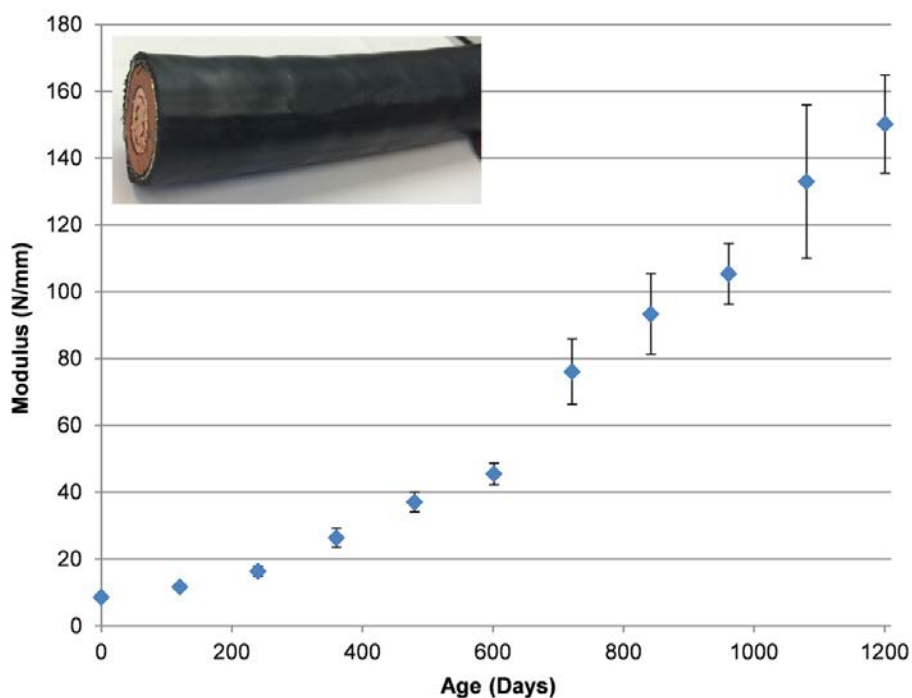

Figure 6.4. Plot of Indenter Modulus vs. Time at 140°C in Air for Shielded EPR Cable with Jacket

6.5 Dynamic Mechanical Analysis

PNNL used an advanced measurement system from TA Instruments and a technique known as dynamic mechanical analysis. DMA measurements are sensitive to polymer transitions, levels of crystallinity, chain scission, and crosslinking (Sepe 1998). The DMA measures the material response to the stimulated stressors applied. The stressors can be temperature, frequency, applied stress, or applied strain, and the DMA can be used to characterize the material's properties as a function of temperature, time, frequency, stress, and atmosphere. The DMA can also be used in thermomechanical analysis mode

that can simulate not only the indenter test, but also look at mechanical stressors such as tensile, creep, and stress relaxation.

The DMA measurements typically apply a sinusoidal force at a 1 Hz frequency while sweeping temperature from -150°C to 150°C or higher at $2^{\circ}\text{C}/\text{min}$. The test geometry can vary with tensile grips for specimens of thin geometries up to 3–4 mm in width. The shear stress mode using various probe tips can have different geometries depending on the stress level of interest. PNNL has used a 0.91 mm probe diameter with right cylinder geometry. Cross-section samples of ~ 5.5 mm thick and ~ 0.635 mm wide were cut from aged tensile specimens and subjected to DMA measurement conditions. The DMA tensile mode used geometries of 3 mm wide and 1.5 mm thick. Okonite provides EPR cable material compound for testing in 15 cm \times 15 cm sheets, 1.5 mm thick.

Figure 6.5 illustrates how the system is configured to measure the material properties. The oscillating probe with its applied stress and measured strain compares the lag between the applied and measured conditions to calculate storage and loss moduli. The storage and loss moduli are the stored (elastic in-phase) and dampened (viscous out-of-phase) energy components, respectively. The ratio of the loss to stored moduli, a measurement of energy dissipation in the material, is the $\tan \delta$. The $\tan \delta$ is analogous to that of the electrical property measurements of which the ratio is a measurement of the lag between the applied and measured loads.

Figure 6.6 illustrates how information from DMA measurements can be used to compare changes in materials based on process conditions or changes in the polymer structure and morphology. Given the types of information that are available from these measurements, it is apparent that DMA is an extremely valuable tool for polymer characterization.

DMA storage modulus data is related to tensile modulus for the material. This type of data is valuable for assessing techniques for acoustic measurements and the change in properties as it thermally degrades. In Figure 6.7, the DMA storage and loss modulus data from the Okoguard jumper cable is shown in the baseline, unaged condition. The data reveals a glass transition temperature of -48°C and very compliant soft material at room temperature relative to its high stiffness below the glass transition. The rise in storage modulus of the Okoguard cable with oven aging is illustrated in Figure 6.8.

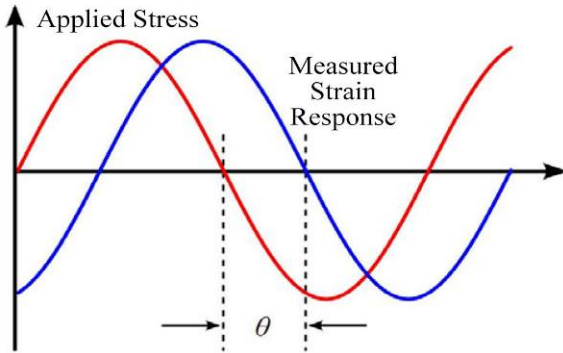
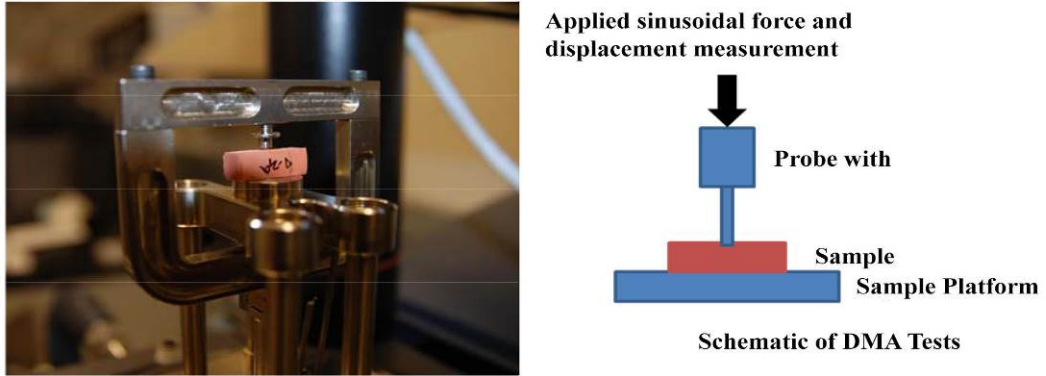

(a)

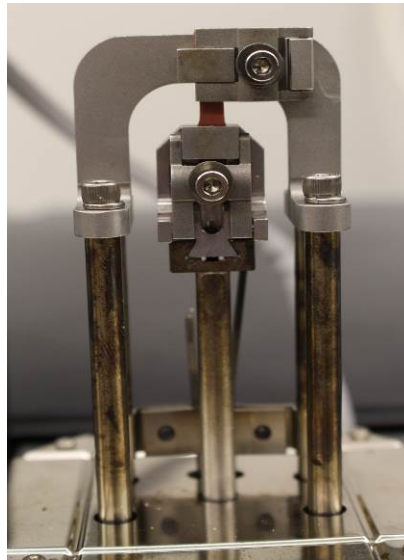

(b)

Figure 6.5. (a) Image of the DMA Instrument with Compression Tip for Shear Modulus and an Illustration of a Simple Schematic and Input/Output Waveforms for Analysis; (b) Photograph of Tensile DMA Instrument Setup with Cable Insulation Specimen

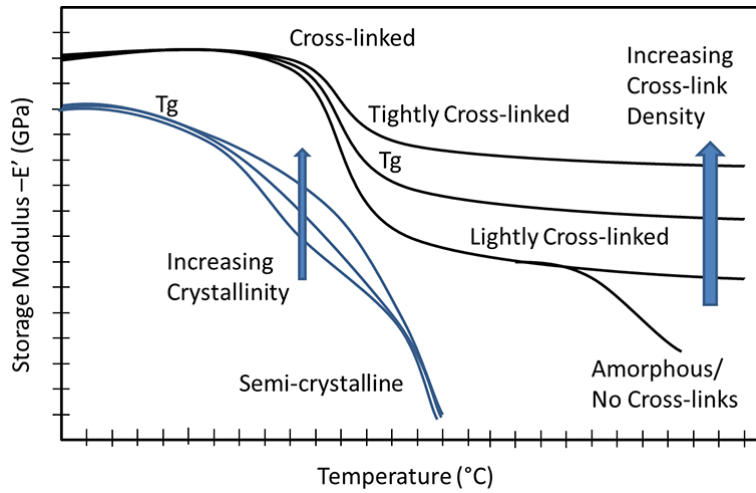

Figure 6.6. DMA Data Schematic Illustrating the Available Information Determined by DMA

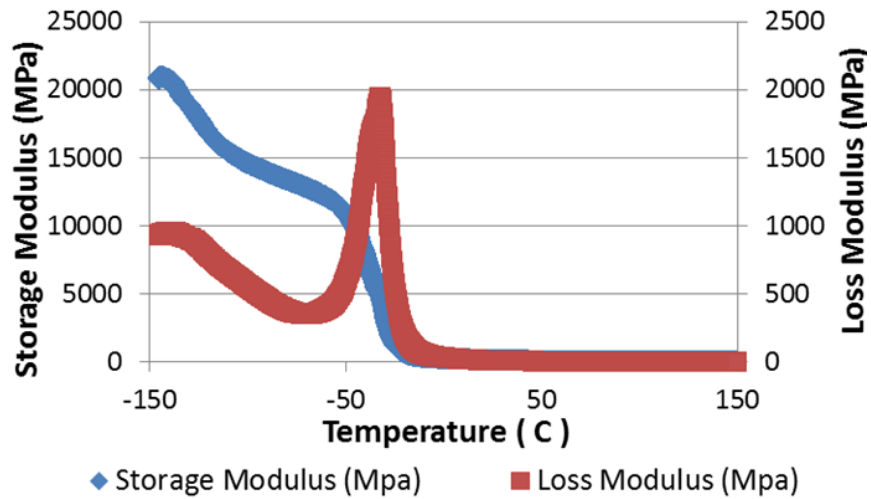

Figure 6.7. DMA Data for Unaged Okoguard Jumper Cable

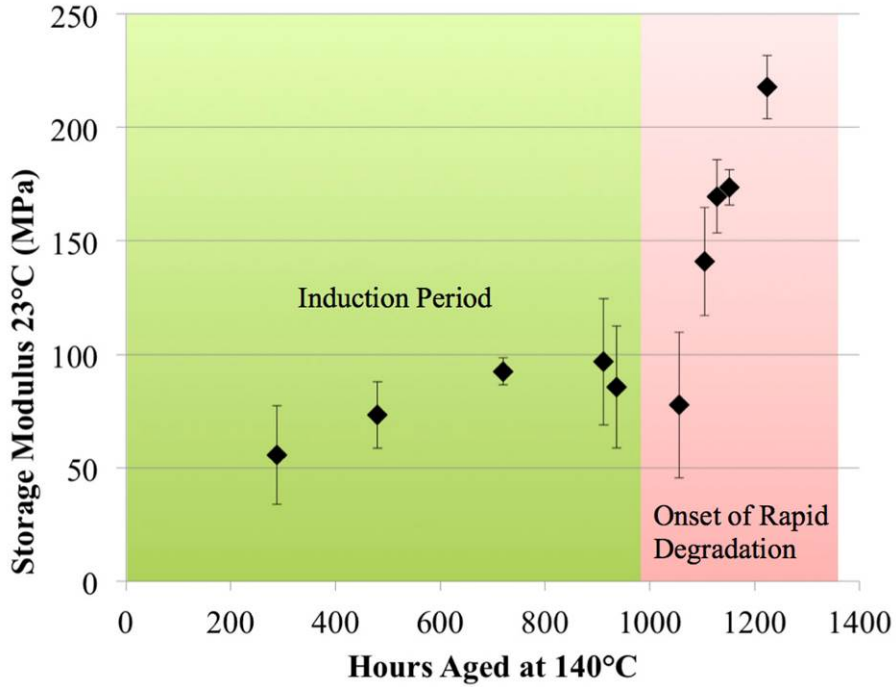

Figure 6.8. Storage Modulus of 140°C Thermally Aged EPR Okoguard Jumper Cable

6.6 Ultrasonic Measurements of Sound Speed and Attenuation

Acoustic wave interactions with solids depend on mechanical properties of the material (Pao 1983) such as density and elastic moduli (Krautkrämer and Krautkrämer 1990). In solids, these waves are also referred to as elastic or stress waves. The behavior of acoustic waves in solids is also a function of the wave mode. The three bulk wave modes usually considered are longitudinal or compressional (called L or P), horizontally polarized shear (SH), and vertically polarized shear (SV). In addition to these modes, surface and plate wave modes (and other modes) can also be generated, depending on the particular parameters and component geometry.

The wave speed c_l in solids for compressional waves is given by (Krautkrämer and Krautkrämer 1990):

$$c_l = \sqrt{\frac{E}{\xi} \frac{1-\mu}{(1-\mu)(1-2\mu)}} \quad (6.2)$$

where E is the modulus of elasticity (units: N/m^2), ξ is the material density (kg/m^3), and μ is Poisson's ratio for the material (a dimensionless quantity). For plane waves or spherical waves, the sound pressure p (related to the applied force) and (compressional) displacement ζ are related by (Krautkrämer and Krautkrämer 1990):

$$p = \xi c_l \omega \zeta = Z \omega \zeta \quad (6.3)$$

where Z is the acoustic impedance.

These two relations indicate that sound speed measurements may be a proxy to measuring the elastic modulus. Several studies have shown a strong correlation between aging jacket material and speed of sound for PVC sheaths and jacket material (Ikehara et al. 1998). PNNL tried to use these techniques on EPR cable samples with limited success. The EPR samples are relatively soft material with strong sound

attenuation and due to signal distortion along the sound path, some variability of the sound velocity measurement was observed. To counter this, the cable was scanned as shown in Figure 6.9.

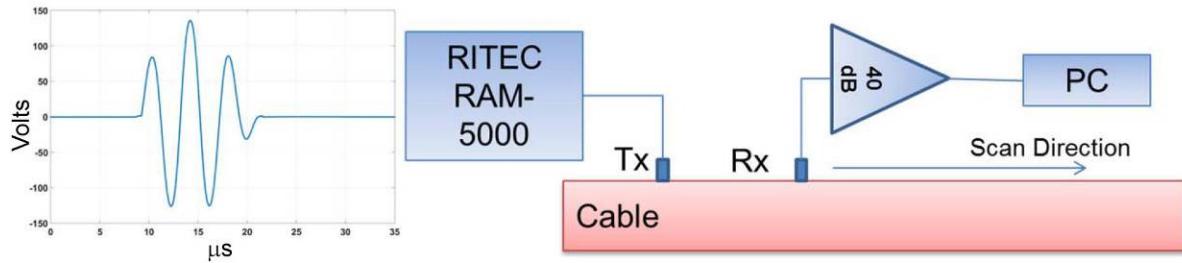

Figure 6.9. UT Velocity Measurement Setup for EPR Cable

The arrival time of the transmitted waveform was difficult to pinpoint. Several advanced algorithms were attempted including auto-correlation, spatial-temporal 2-D Fourier transforms, and scanned least-squares fit regression analysis of the constant phase demarcation of the first-arrival wave packet. The regression analysis produced the most reliable repeatable velocity measurements (Figure 6.10).

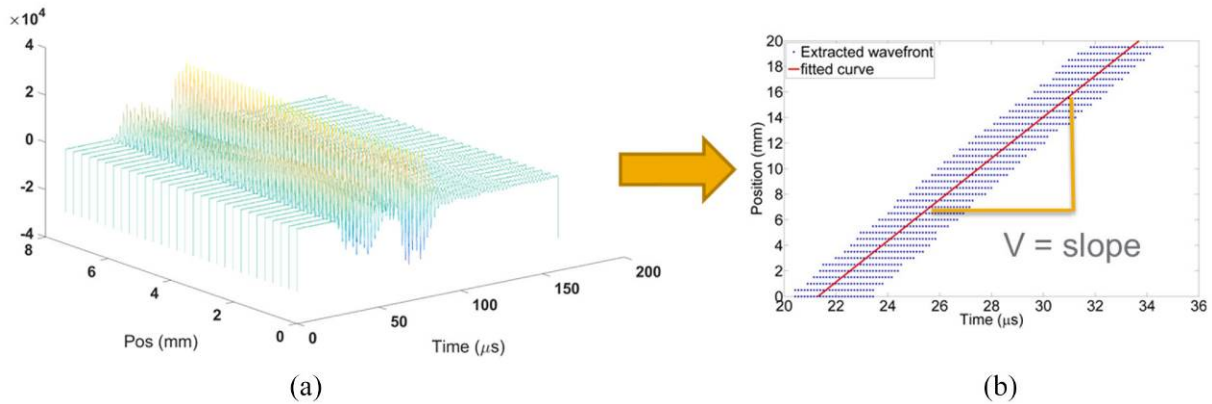

Figure 6.10. Waveforms at Each Scan Location (a) are Discretized for First Arrival Wave-Packet. This position/time plot is then subject to a regression analysis for more consistent velocity measurement (b).

This approach was used to measure the sound velocity in a set of EPR samples exposed to up to 1200 hrs. (50 days) at 140°C (Figure 6.11). Such a period of thermal aging would be expected to reduce the EAB to below 25 percent (Figure 6.2). Transducer excitation frequencies of 250 kHz, 500 kHz, and 750 kHz were used. Significantly higher frequencies were rejected due to material attenuation, which limited sound propagation beyond a few inches. There was still some spread in the data but most of the measurements were relatively consistent. The sound velocity results, however, showed poor correlation with the EPR sample's thermal exposure time.

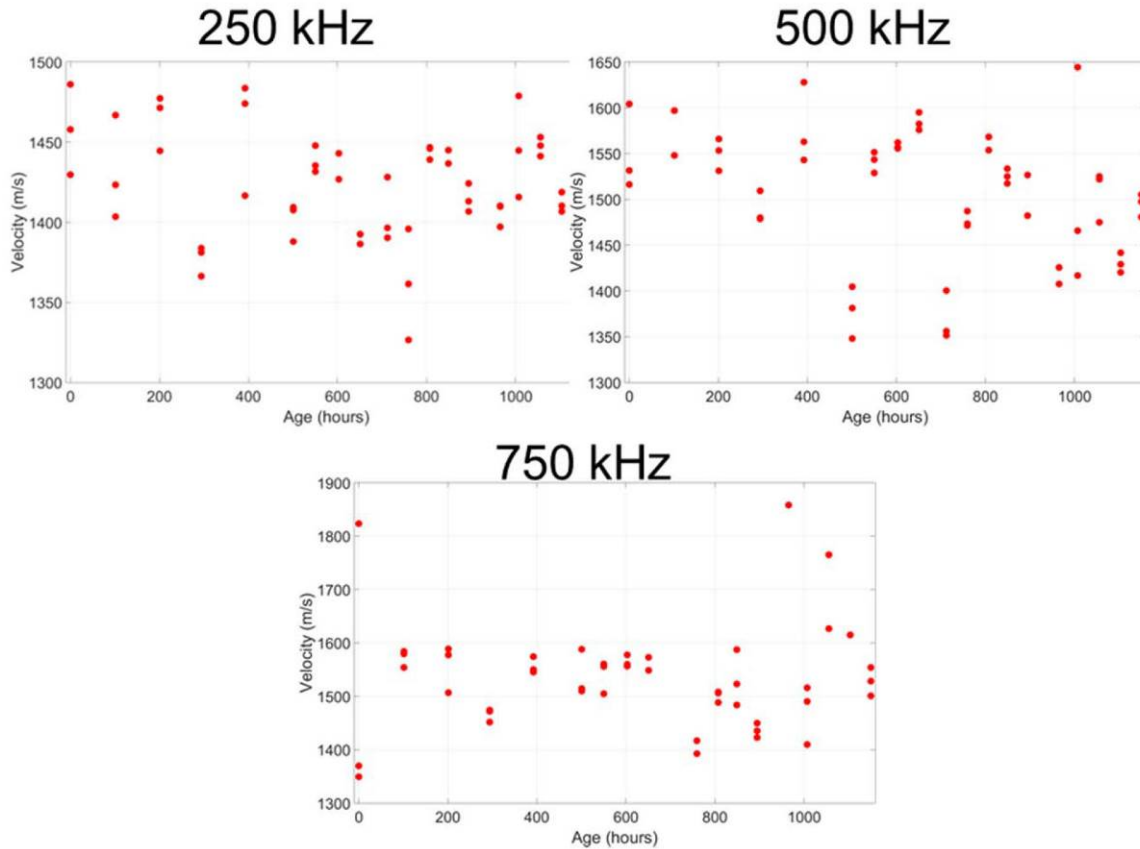

Figure 6.11. EPR Ultrasound Velocity as a Function of Accelerated Thermal at 140°C Aging Shows Poor Correlation

This poor correlation between thermal aging versus laboratory ultrasonic velocity measurements does not encourage development of a field-deployable in-situ measurement approach. Although such an in-situ system could be envisioned, other techniques seem to have better correlation to the parameter of interest and would be easier to implement for in-situ tests within NPPs.

6.7 Interdigital Capacitor Technique

In addition to the VNA-based reflection coefficient measurements using the coaxial dielectric probe, low-frequency capacitance measurements with a conformal sensor placed on the cable were performed to investigate changes in dielectric properties as a function of aging. These measurements were conducted using the custom-designed interdigital capacitor and Agilent 4294A precision impedance analyzer shown in Figure 6.12. Interdigital sensors are a mature technology and have been widely used in numerous applications for many years (Hobdell 1979; Mamishev et al. 2004; Abu-Abed and Lindquist 2008). Recent work has been published on the design of interdigital sensors for nondestructive evaluation of aircraft wire insulation dielectric properties to detect material degradation (Sheldon and Bowler 2013). Because the device capacitance is linearly proportional to the material dielectric constant and independent of the applied test voltage, this type of sensor was also selected for an initial characterization of the aged cable sections at low frequencies. Another compatible feature of the interdigital sensor is that only single-sided access to the material sample is required.

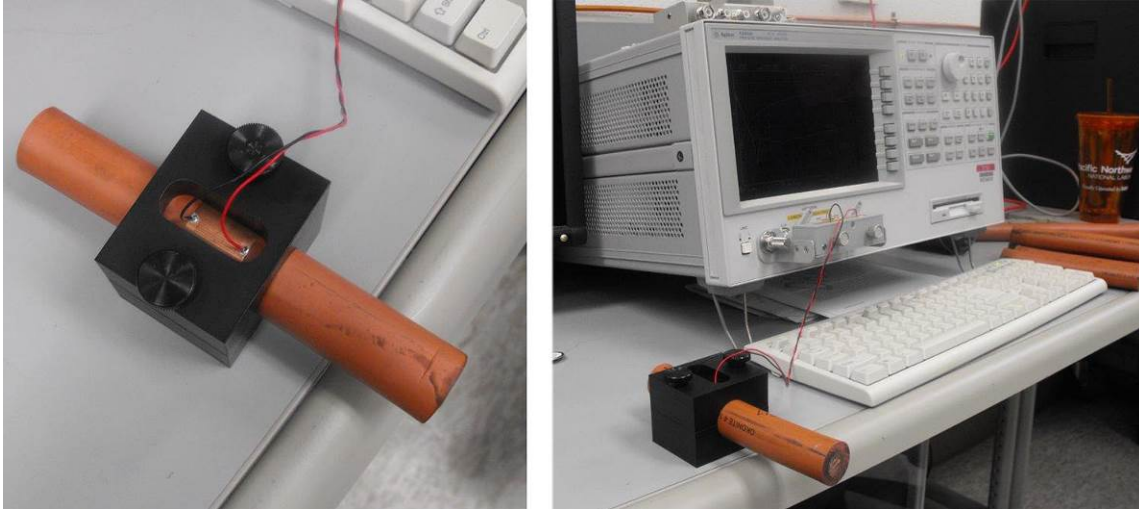

Figure 6.12. Experimental Configuration for Capacitance Measurements Showing Impedance Analyzer and Clamshell Fixture Used to Wrap the Sensor onto the Outer Surface of the Cable

The interdigital sensor shown in Figure 6.12 was designed using the Ansys Maxwell electrostatic finite element simulation software. The design geometry consists of a 15-electrode capacitor printed on a thin flexible polyimide substrate with an approximate width of 13 mm and length of 25 mm. The measured capacitance of the sensor installed on an unaged reference cable was 15 pF at 10 MHz, which agreed well with the predicted value of 13 pF. Figure 6.13 shows the simulation model of the sensor wrapped onto the cable insulation and the penetration of the electric field through the cable cross section. For this design, the calculated electric field penetrated into the uppermost 1–2 mm of the cable insulation and the capacitance measurements were performed over a frequency range of 10–100 MHz.

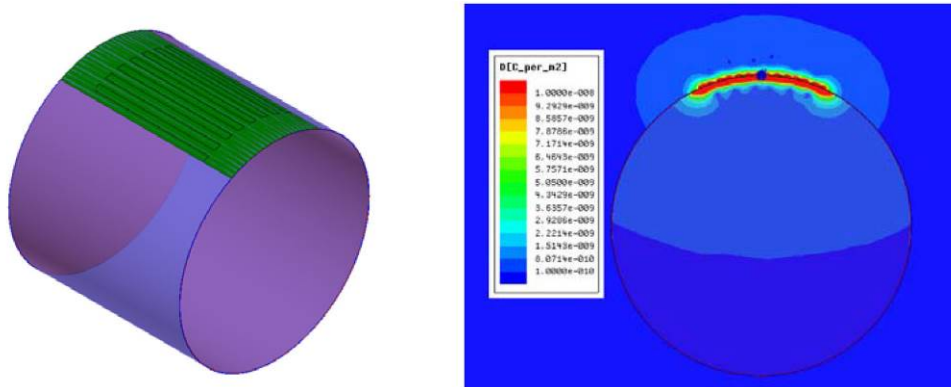

Figure 6.13. Electrostatic Field Simulation Model of Interdigital Capacitive Sensor and Electric Flux Distribution Inside Cable Insulation

6.8 Embedded Micro Sensors

AgeAlert™ (PAC 2012) is a type of micro sensor developed to measure aging or degradation of electrical insulation. The sensor is made using the insulation of a cable and nano-size conductive particles. In this way, the sensor becomes a “variable resistor” responding to temperature, humidity, and other environmental stressors in a similar way to the insulation. Comparing sensor resistance to sensors subjected to accelerated aging and the manufacturer’s design testing (such as EAB) allows correlation of sensor data to monitored cable condition. The sensor is embedded in or bonded to the cable so that it is subject to the same environment as the insulation. The sensors are installed on the cable to continuously track aging of cable due to thermal, chemical, and radiation environments and are capable of giving

warning before design aging conditions are exceeded. The cable condition can be read by contact with simple resistance measuring readers or by wireless readers such as a passive radio frequency identification device. The sensors can be installed by OEM wire/cable manufacturers during manufacture. Alternatively, they can be bonded to wire cable. Advantages of such a system are primarily the ease of checking on the sensor's condition and such sensors could provide a basis for a screening program to identify likely cables for CM checks and/or candidate cables for a more relaxed inspection interval. Disadvantages are that the sensors must be located at the highest stress areas of the cable to provide a meaningful indication of the cable's weakness. In addition, installing such sensors in existing plants with cables that are already significantly aged cannot justify a relaxed CM program for such instrumented cables. Although this technology is being discussed among industry groups, no currently implemented programs are known within the nuclear industry.

7. SUMMARY

Cable aging is considered to be one of the factors that may limit the ability of light water reactors to continue operations beyond their licensed period (up to 60 and 80 years, depending on the specific plant). The most important requirement for cables (electrical or instrumentation) in NPPs is the ability to withstand a DBE. This is an active global issue with significant ongoing research; however, the industry is generally agreed on practical guidelines for managing the cable aging issue. Licensees are encouraged to select a sample of cables based on accessibility, risk, and environment as lead cables representing the complete population of cables for regular condition monitoring and trending. The sample and test regime includes history and experience for specific and typical failures or detection of degradation. Although there is no single test that can confirm an acceptable condition for all cables, there are numerous tests that can be applied for a strong indication of cable condition. Tests are generally grouped into two domains: (1) bulk electrical tests and (2) local tests.

Bulk electrical tests can generally confirm the condition of the entire cable length. Some tests can also identify the location of weak parts of the cable. Such electrical tests, however, do not work well for some cable designs including single cables and un-shielded cables. Leading bulk electrical tests include FDR low-voltage tests and $\tan \delta$ high-voltage tests. This report particularly focuses on the challenge of unshielded triplex cable, which is known to have very high noise. The FDR was able to identify small cable sections where the insulation was completely removed; however, noise levels were quite high and the likelihood of detecting such failures would be much higher if the measurement were a comparative measurement with respect to a baseline rather than an absolute measurement.

Local measurements include numerous test approaches including infrared spectroscopy indenter, DMA, visual test, infrared thermography, interdigital capacitance, and embedded micro sensors. Each of these tests can provide information for an effective cable management program to support practical decisions regarding replacement, repair, or leave the cables in service while maintaining adequate safety margins for design-basis events.

8. PATH FORWARD

Research going forward will focus on viability assessment of measurements of chemical, mechanical, and electrical key indicators that can provide data correlated to cable aging, and determine whether these diverse sets of measurements can provide synergistic information that can more effectively help in decisions on repair and replacement. Particular attention will be awarded to the most promising techniques including $\tan \delta$ and FDR bulk measurements, plus DMA, interdigital capacitance, and other local measurements as applied to a slightly wider set of cables.

For FDR bulk measurements, interest is in characterizing different responses between shielded and unshielded cable. In addition, there are three primary vendors of FDR instruments and software. PNNL owns one system and has an offer for collaboration with a second system vendor to evaluate performances of two different software and hardware implementations.

$\tan \delta$ measurements are widely accepted for shielded medium-voltage cables. This approach seems appropriate to adapt and test for low-voltage shielded cables noting that low-voltage cables constitute the vast majority of NPP cables.

The most practical and interesting local measures of jacket and insulation condition seem to be:

- Indenter
- Interdigital capacitance
- FTIR
- Field adaptation of a DMA tester (particularly focusing on XLPE and other materials not well suited to indenter measurements).
- Embedded Micro Sensors

The program should integrate these measurements with aging material samples to capitalize on synergies with accelerated aging capabilities. Note that the above tasks represent cable test approaches that have not been addressed in the literature to date and can contribute to practical applications and advancement of cable aging management programs.

In addition, some harvested cables are expected in the coming period that may be suitable for application of a range of techniques as outlined above. Evaluation of these cables as-received and following subsequent laboratory aging is expected to inform the suitability of the applied techniques to cable condition evaluation.

The above tasks are subject to prioritization and scheduling in conjunction with project stakeholders.

9. REFERENCES

- Abu-Abed AS and RG Lindquist. 2008. "Capacitive Interdigital Sensor with Inhomogeneous Nematic Liquid Crystal Film." *Progress in Electromagnetics Research B* 7:75-87.
- ADVANCE. 2013. *ADVANCE - Publishable Summary - Ageing Diagnostics and Prognostics of Low-Voltage I&C Cables*. Grant Agreement 269893, Electricité de France, Paris.
- EPRI. 2005. *Initial Acceptance Criteria Concepts and Data for Assessing Longevity of Low-Voltage Cable Insulations and Jackets*. TR-1008211, Electric Power Research Institute (EPRI), Palo Alto, California.
- Fantoni PF. 2007. *Wire System Aging Assessment and Condition Monitoring (WASCO)*. NKS-157, Institutt for energiteknikk, IFE, Norway. ISBN 978-87-7893-221-1.
- Fifield LS, MP Westman, A Zwoster and B Schwenzer. 2015. *Assessment of Cable Aging Equipment, Status of Acquired Materials, and Experimental Matrix at the Pacific Northwest National Laboratory*. PNNL-24198, Pacific Northwest National Laboratory, Richland, Washington.
- Gillen KT, M Celina and RL Clough. 1999. "Density Measurements as a Condition Monitoring Approach for Following the Aging of Nuclear Power Plant Cable Materials." *Radiation Physics and Chemistry* 56(4):429-447.
- Guerout FM, L Cisse and R Boor. 2009. "New Non-Destructive Condition Monitoring Techniques for On-Site Assessment of Low-Voltage Cables." In *Proceedings of the 17th International Conference on Nuclear Engineering 2009 (ICONE17)*, pp. 61-70. July 12-16, 2009, Brussels, Belgium. American Society of Mechanical Engineers, New York.
- Hobdell J. 1979. "Optimization of Interdigital Capacitors." *IEEE Transactions on Microwave Theory and Technology* 79(9):788-791.
- IAEA. 2012. *Assessing and Managing Cable Ageing in Nuclear Power Plants*. IAEA Nuclear Energy Series No. NP-T-3.6, International Atomic Energy Agency (IAEA), Vienna.
- IEC. 2002. *Broadband Services, Applications, and Networks: Enabling Technologies and Business Models*. International Electrotechnical Commission (IEC).
- Ikehara J, T Ikeda, T Ashida and M Fujii. 1998. "Degradation Diagnosis of Polymeric Materials Using Ultrasonic Waves." In *Proceedings of the 1998 Ultrasonics Symposium*, pp. 1667-1170, Vol. 2. October 5-8, 1998, Sendai, Japan. DOI 10.1109/ULTSYM.1998.765046. Institute of Electrical and Electronics Engineers Inc., Piscataway, New Jersey.
- Krautkrämer J and H Krautkrämer. 1990. *Ultrasonic Testing of Materials, 4th Fully Revised Edition*. Springer-Verlag, New York. p. 69.
- Mamishv AV, K Sundara-Rajan, F Yang, Y Du and M Zahn. 2004. "Interdigital Sensors and Transducers." *IEEE Proceedings* 92(5):808-845.
- Mantey A and G Toman. 2013. *Plant Engineering: Aging Management Program Guidance for Medium-Voltage Cable Systems for Nuclear Power Plants, Revision 1*. Technical Report 3002000557, Electric Power Research Institute, Charlotte, North Carolina.

- Murty KL, Ed. 2013. *Materials Ageing and Degradation in Light Water Reactors: Mechanisms and Management*. Woodhead Publishing, United Kingdom.
- NRC. 2010. *Condition Monitoring Program for Electric Cables Used in Nuclear Power Plants*. Draft Regulatory Guide DG-1240, U.S. Nuclear Regulatory Commission, Washington, D.C.
- NRC. 2012. *Condition-Monitoring Techniques for Electric Cables Used in Nuclear Power Plants*. Regulatory Guide 1.218, U.S. Nuclear Regulatory Commission, Washington, D.C. ADAMS Accession No. ML103510447.
- NRC. 2013. *Expanded Materials Degradation Assessment (EMDA), Volume 5: Aging of Cables and Cable Systems*. NUREG/CR-7153, Vol. 5; ORNL/TM-2013/532, U.S. Nuclear Regulatory Commission, Washington, D.C.
- PAC. 2012. *AgeAlert - Statement-of-the-Art Predictive Maintenance Sensor Helps You Maximize Uptime and Save Month*. Polymer Aging Concepts, Inc. (PAC). Dahlonega, Georgia. Accessed September 4, 2015. Available at <http://www.agealert.com/>.
- Pao Y-H. 1983. "Elastic Waves in Solids." *Journal of Applied Mechanics* 50(4b):1152-1164.
- Ramuhalli P, LS Fifield, MS Prowant, G Dib, JR Tedeschi, JD Suter, AM Jones, MS Good, SW Glass and AF Pardini. 2015. *Assessment of Additional Key Indicators of Aging Cables in Nuclear Power Plants -- Interim Status for FY2015*. PNNL-24309, Pacific Northwest National Laboratory, Richland, Washington.
- Sepe M. 1998. *Dynamic Mechanical Analysis for Plastics Engineering (PDL Handbook Series)*. Plastics Design Library, Norwich, New York.
- Sheldon RT and N Bowler. 2013. "An Interdigital Capacitive Sensor for Quantitative Characterization of Wire Insulation." In *Review of Progress in Quantitative Nondestructive Evaluation, Vol. 32*, pp. 1578-1585. July 15-20, 2012, Denver, Colorado. American Institute of Physics, Mellville, New York.
- Simmons KL, LS Fifield, MP Westman, JR Tedeschi, AM Jones, MS Prowant, AF Pardini and P Ramuhalli. 2014. *Determining Remaining Useful Life of Aging Cables in Nuclear Power Plants -- Interim Status for FY2014*. PNNL-23624; INL-EXT-14-32505 Rev. 0, Pacific Northwest National Laboratory, Richland, Washington.
- Simmons KL, P Ramuhalli, DL Brenchley and JB Coble. 2012. *Light Water Reactor Sustainability (LWRS) Program – Non-Destructive Evaluation (NDE) R&D Roadmap for Determining Remaining Useful Life of Aging Cables in Nuclear Power Plants*. PNNL-21731, Pacific Northwest National Laboratory, Richland, Washington.
- Villaran M and R Lofaro. 2010. *Essential Elements of an Electric Cable Condition Monitoring Program*. NUREG/CR-7000; BNL-NUREG-90318-2009, U.S. Nuclear Regulatory Commission, Washington, D.C.
- Yamamoto T and T Minakawa. 2009. *The Final Report of The Project of 'Assessment of Cable Aging for Nuclear Power Plants'*. JNES-SS-0903, Incorporated Administrative Agency Japan Nuclear Energy Safety Organization, Nuclear Energy System Safety Division, Tokyo, Japan.